

Space-time deterministic Graph Rewriting

Pablo Arrighi, Marin Costes, Gilles Dowek, Luidnel Maignan

école _____
normale _____
supérieure _____
paris-saclay _____

université
PARIS-SACLAY



Laboratoire
Méthodes
Formelles

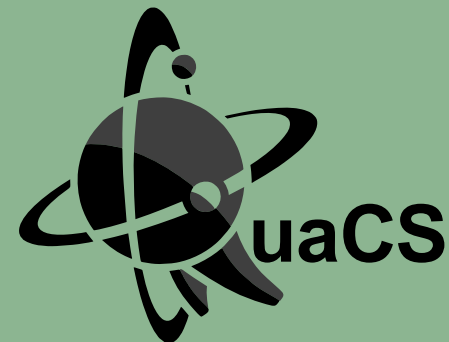

Simulating physics

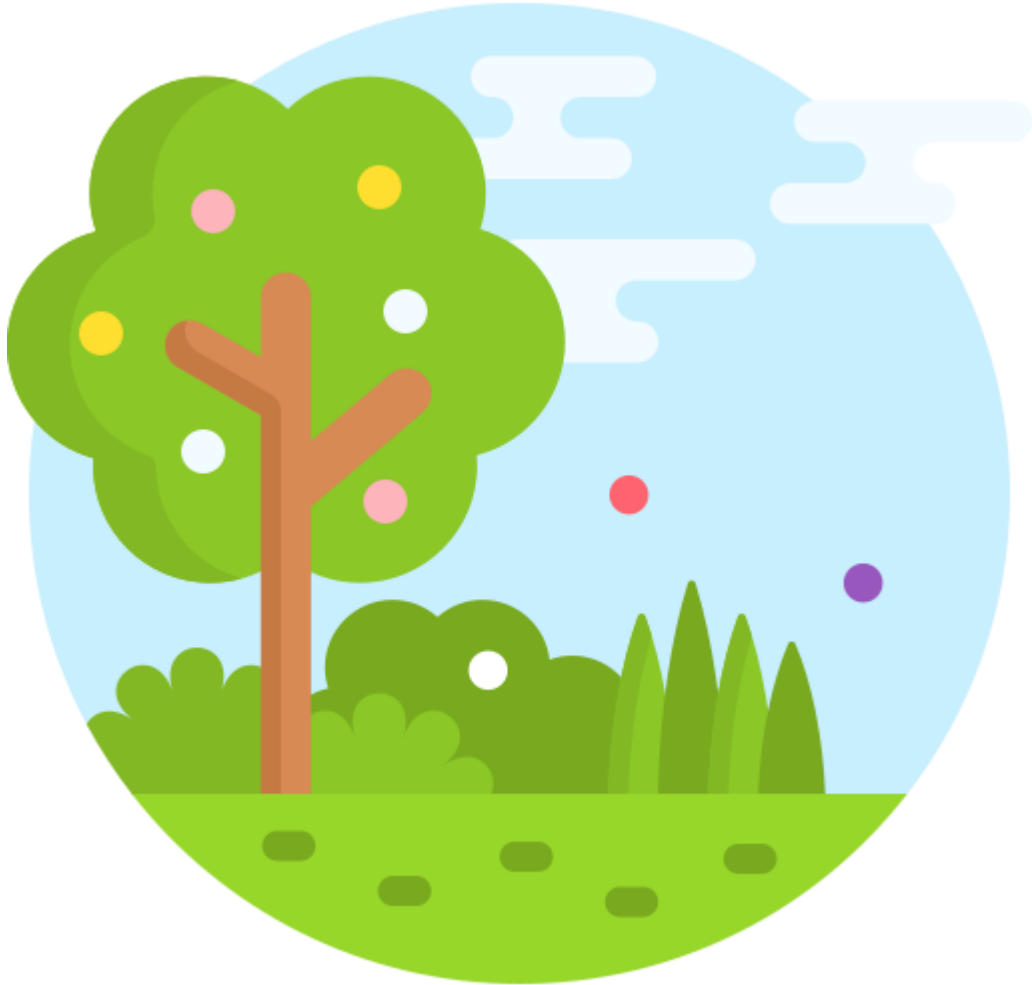

Simulating physics

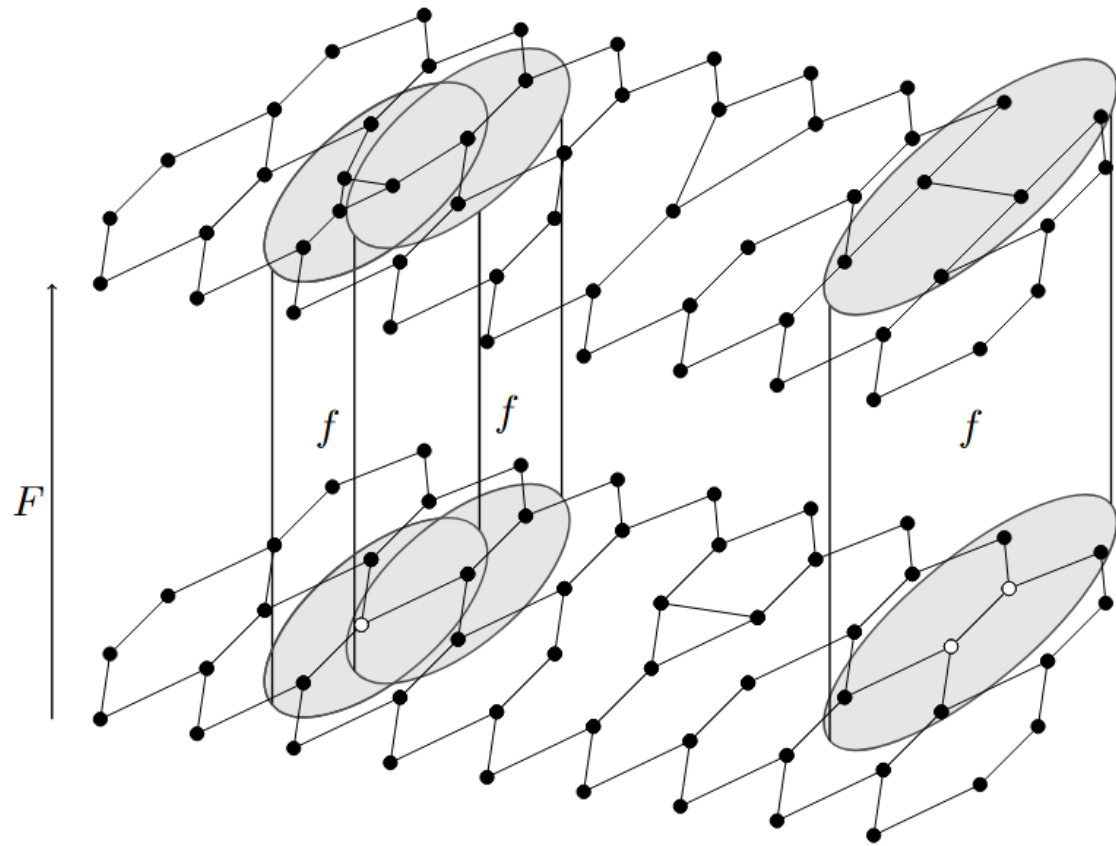

Simulating physics

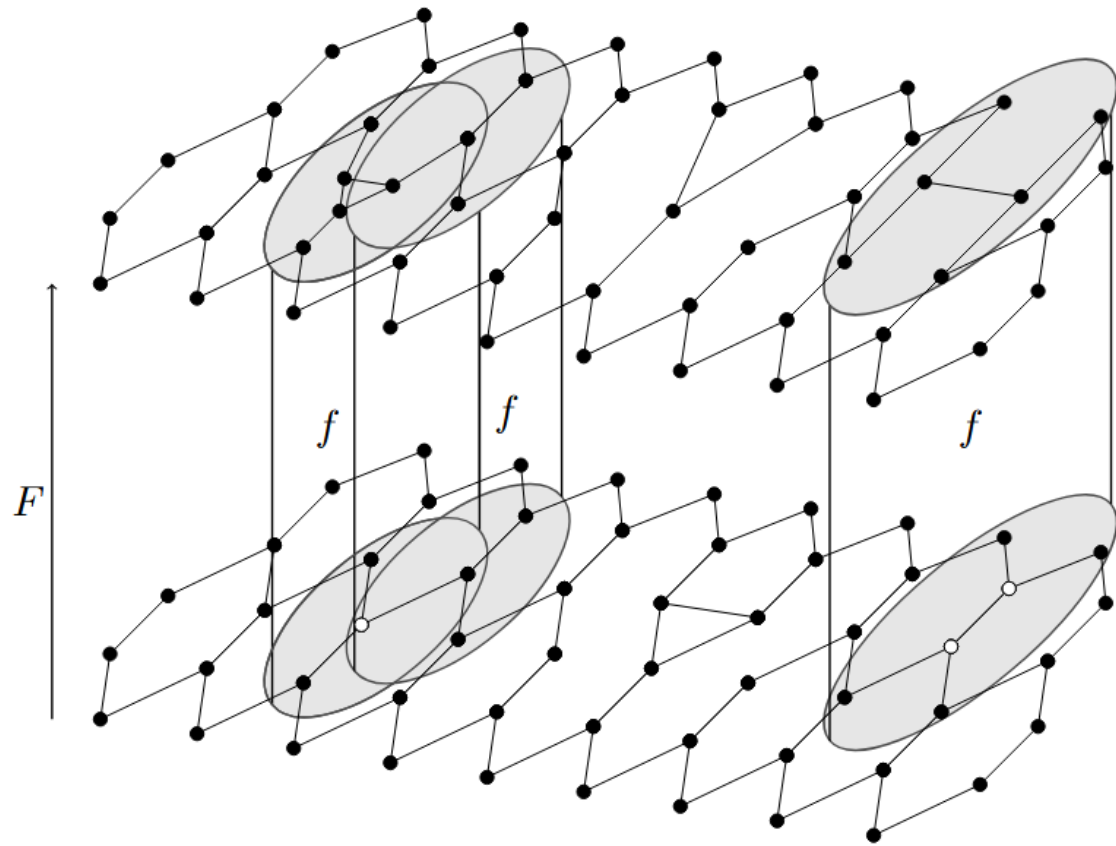

\neq

No global clock in physics !

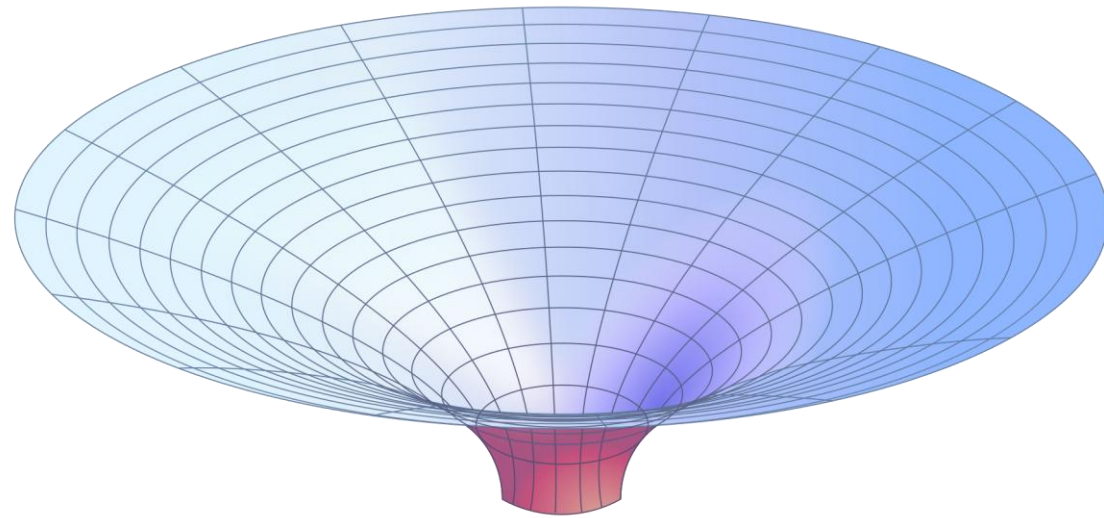

Dynamical systems and rewriting

**Dynamical system
(Synchronous)**

time

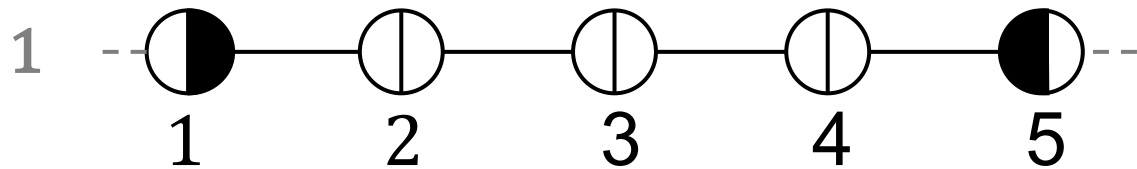
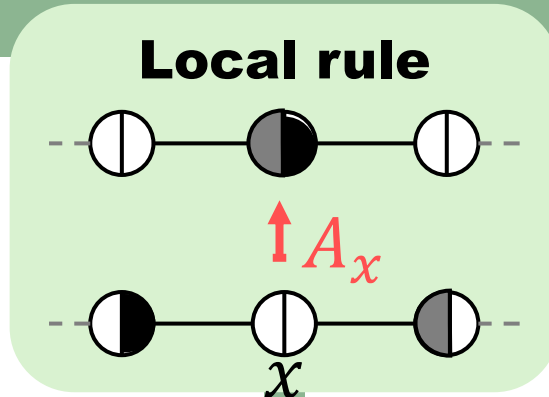

Dynamical systems and rewriting

**Dynamical system
(Synchronous)**

Local rule



$\uparrow A_x$



x

time

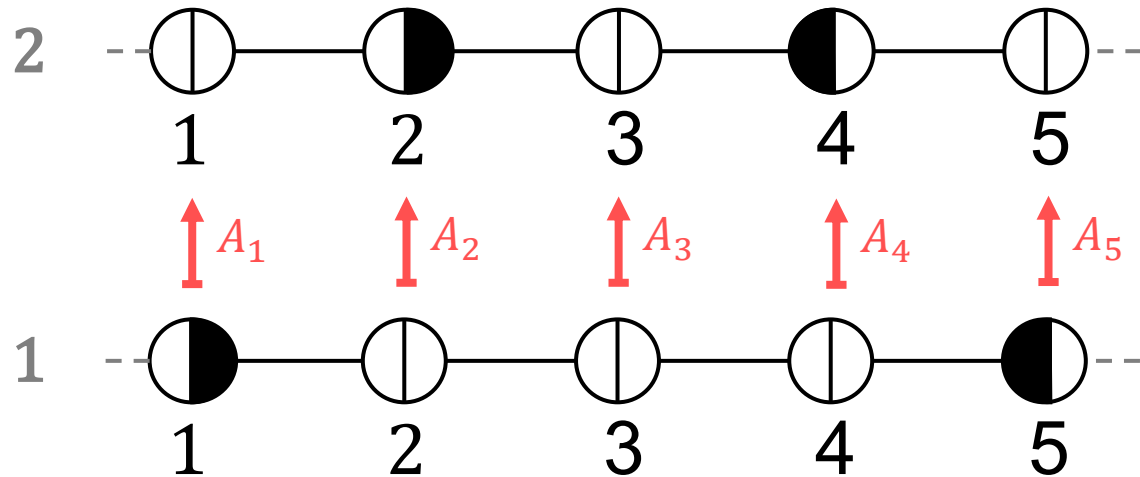

Dynamical systems and rewriting

**Dynamical system
(Synchronous)**

time

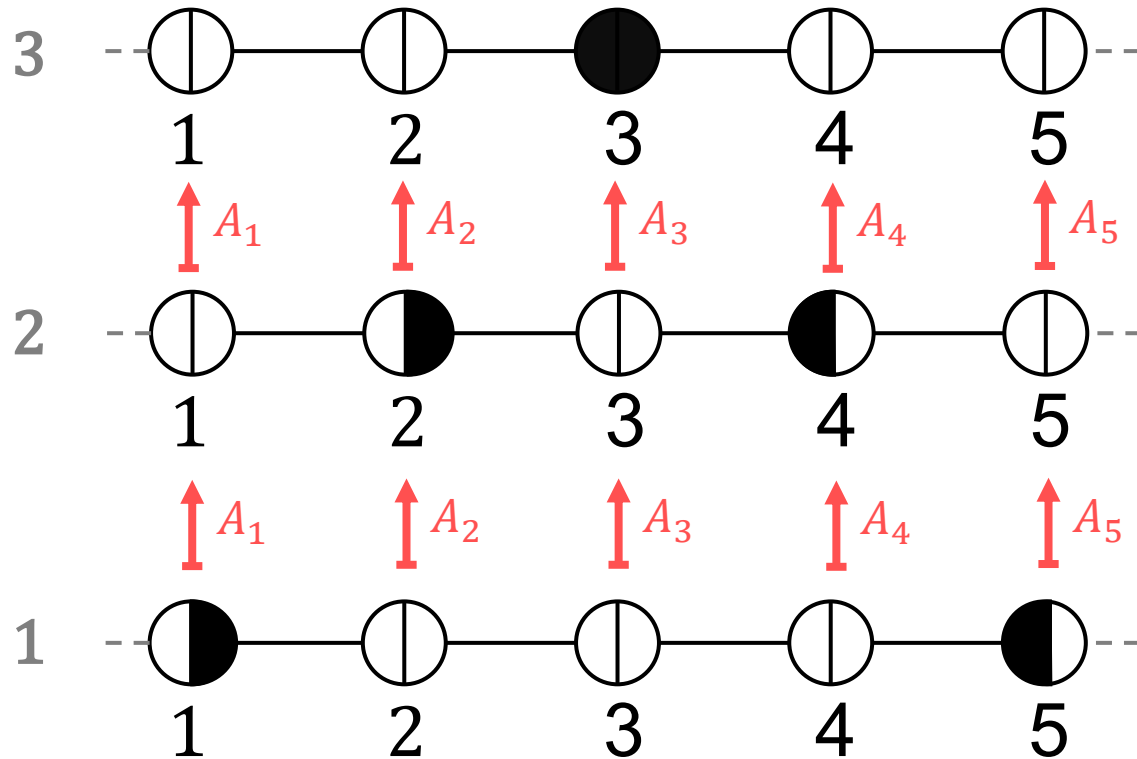

Local rule

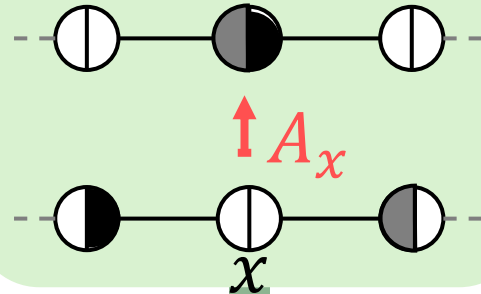

Dynamical systems and rewriting

**Dynamical system
(Synchronous)**

time

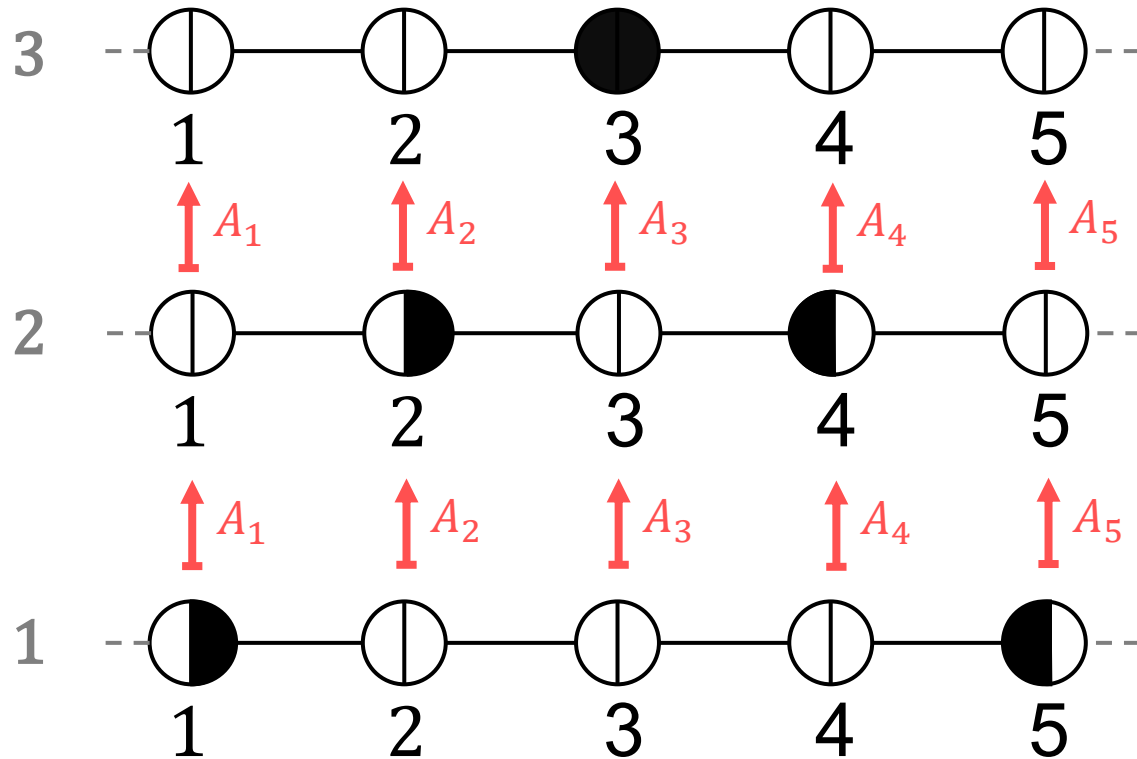

Local rule

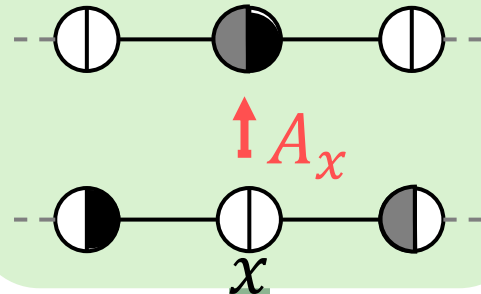

**Graph rewriting
(Asynchronous)**

G

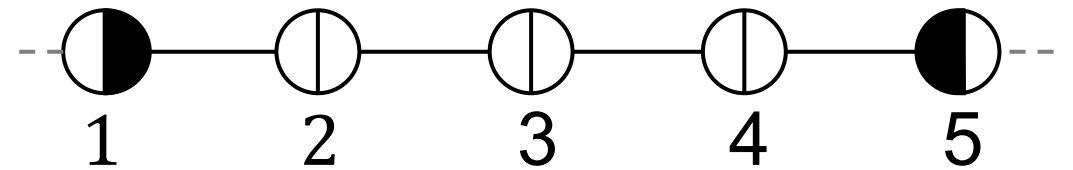

Dynamical systems and rewriting

**Dynamical system
(Synchronous)**

time

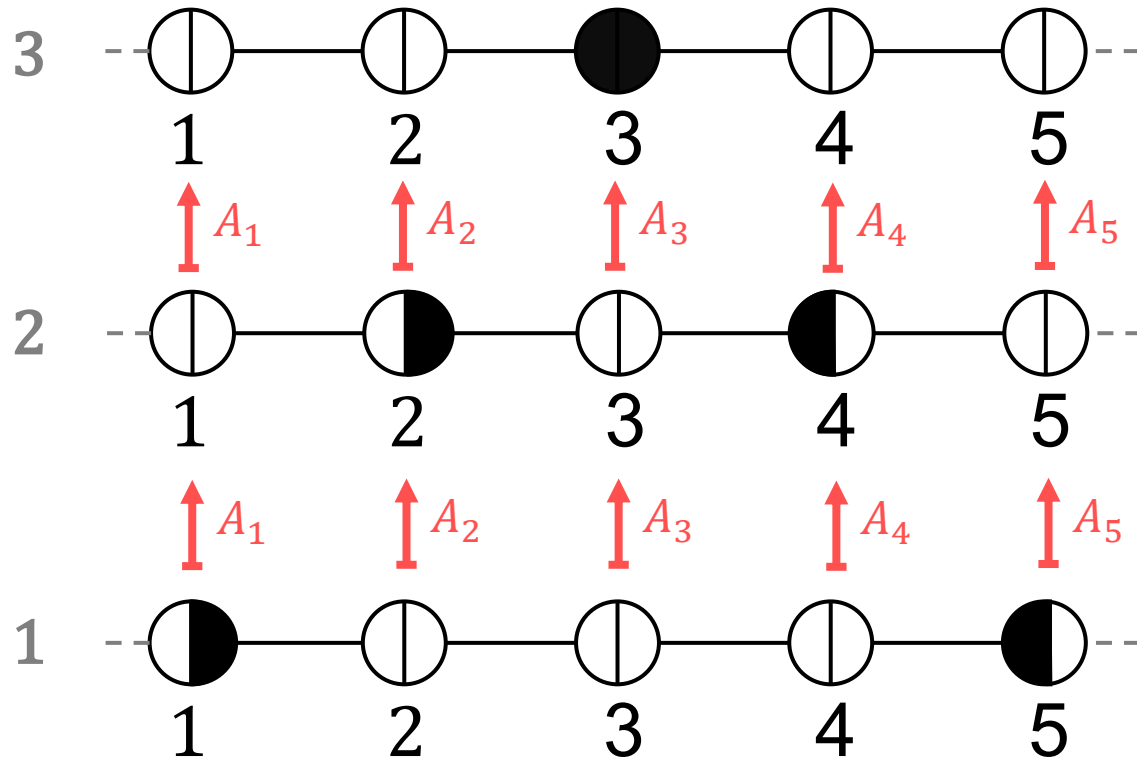

Local rule

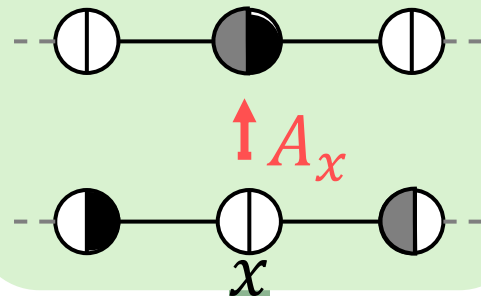

**Graph rewriting
(Asynchronous)**

$A_2 G$

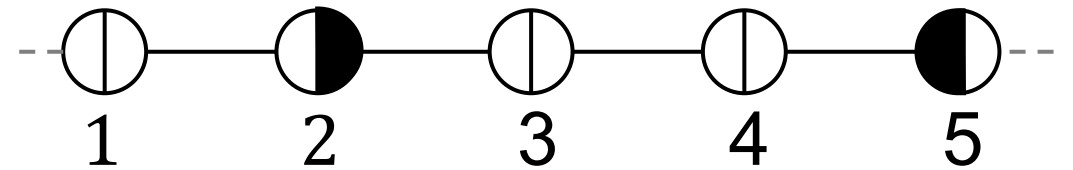

Dynamical systems and rewriting

**Dynamical system
(Synchronous)**

time

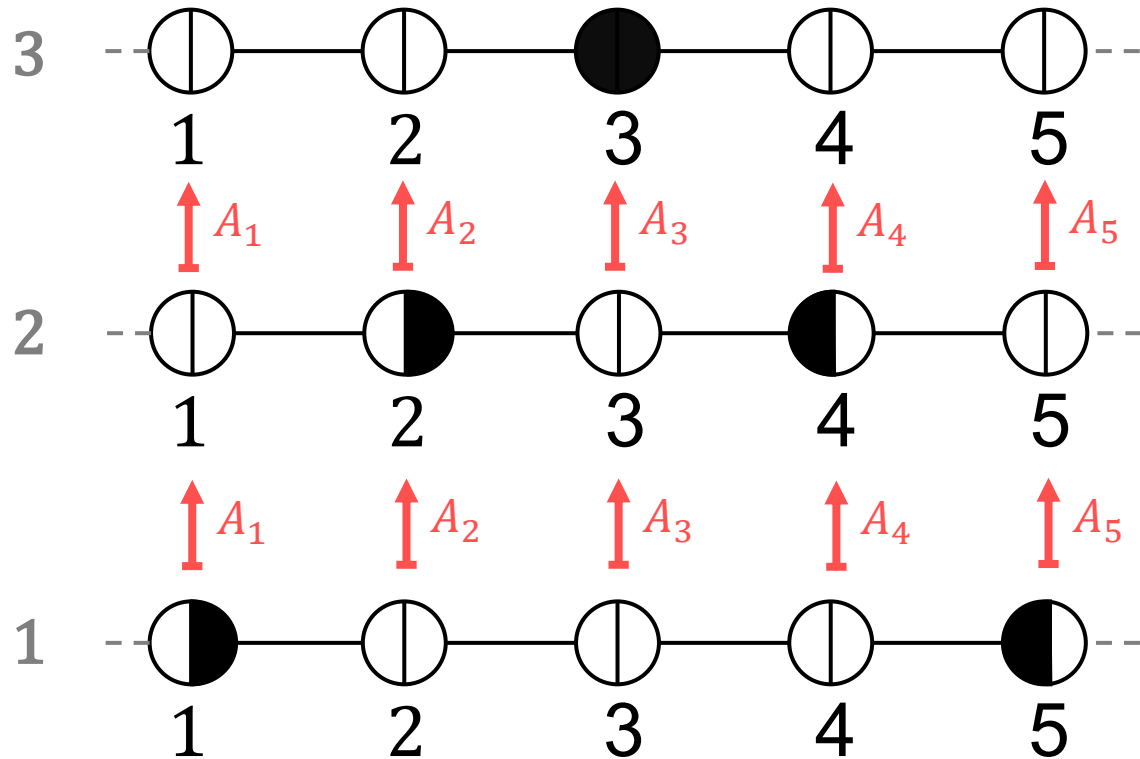

Local rule

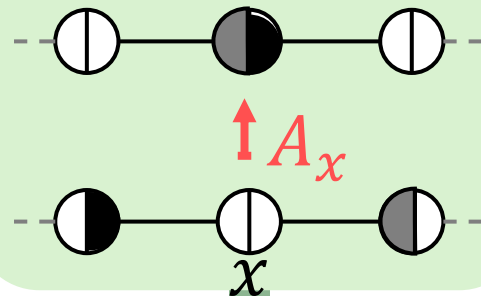

**Graph rewriting
(Asynchronous)**

$A_3 A_2 G$

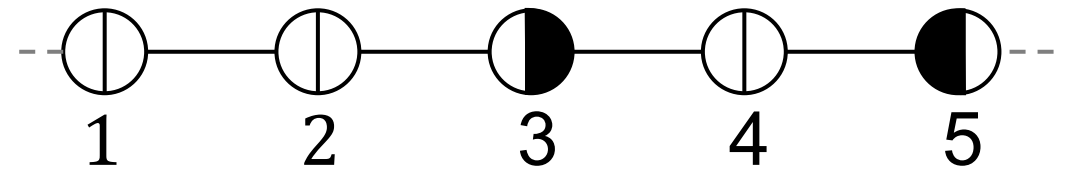

Dynamical systems and rewriting

**Dynamical system
(Synchronous)**

time

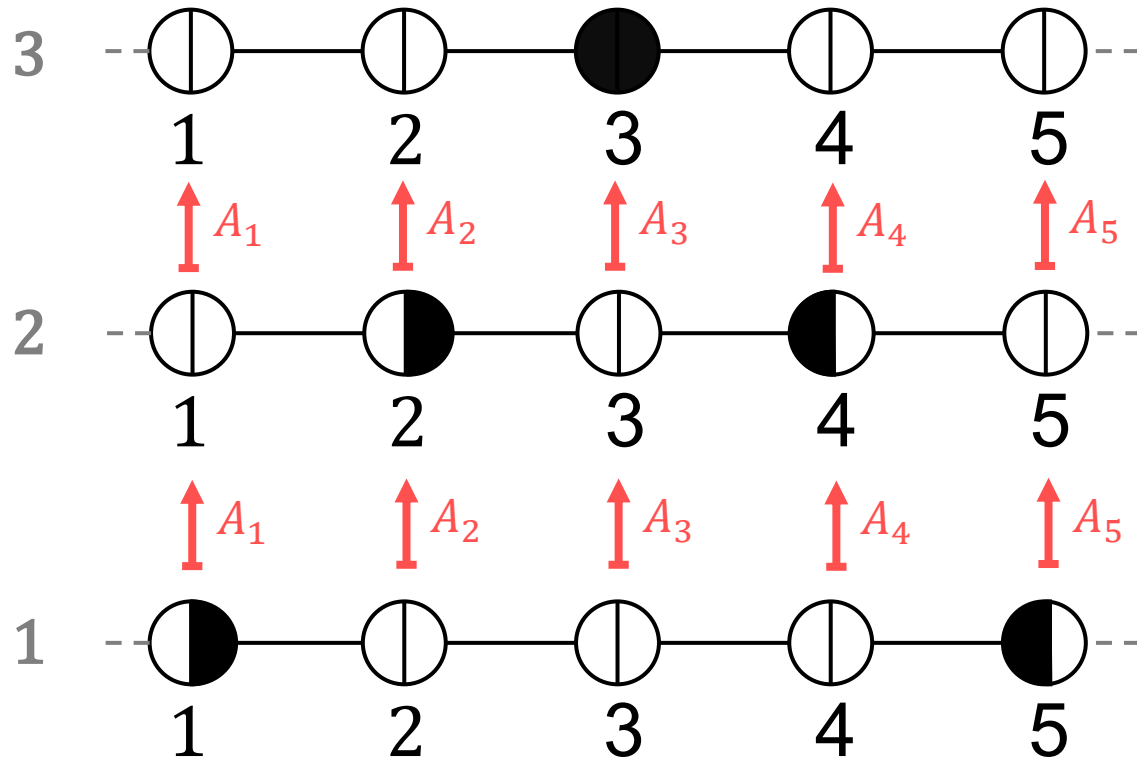

Local rule

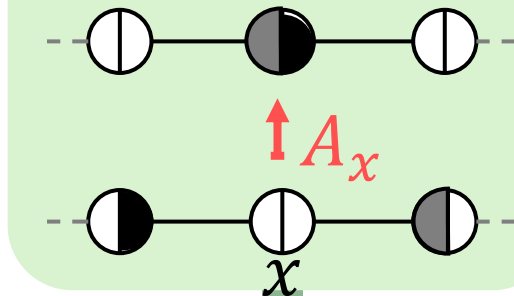

**Graph rewriting
(Asynchronous)**

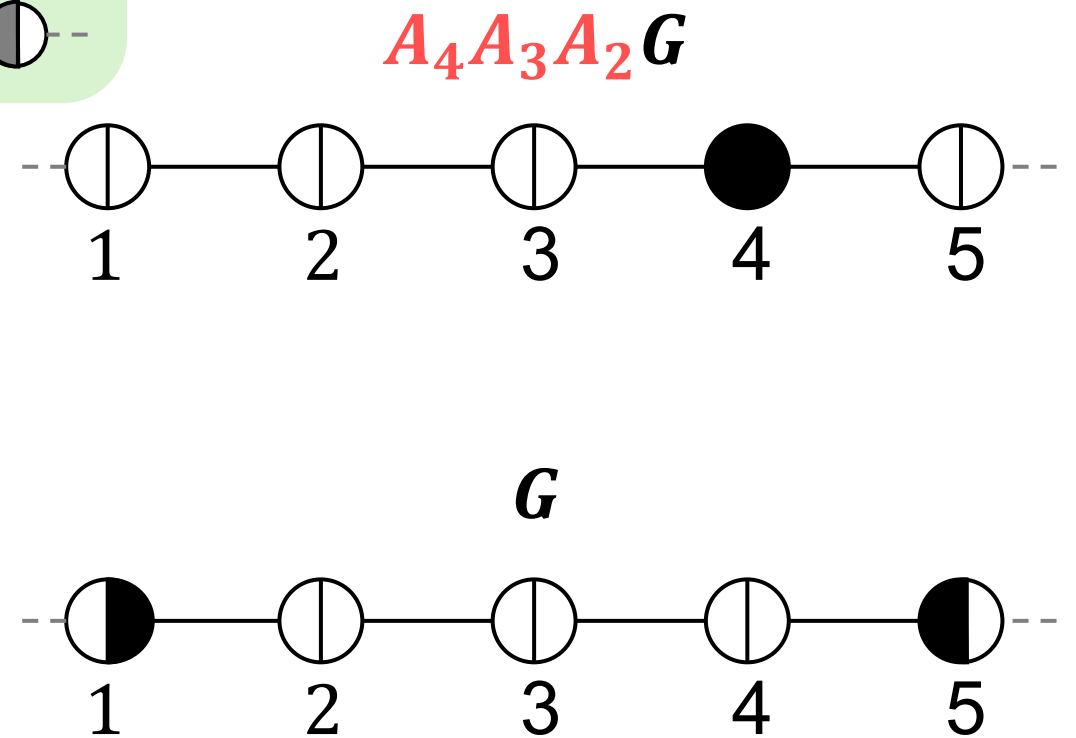

Dynamical systems and rewriting

**Dynamical system
(Synchronous)**

time

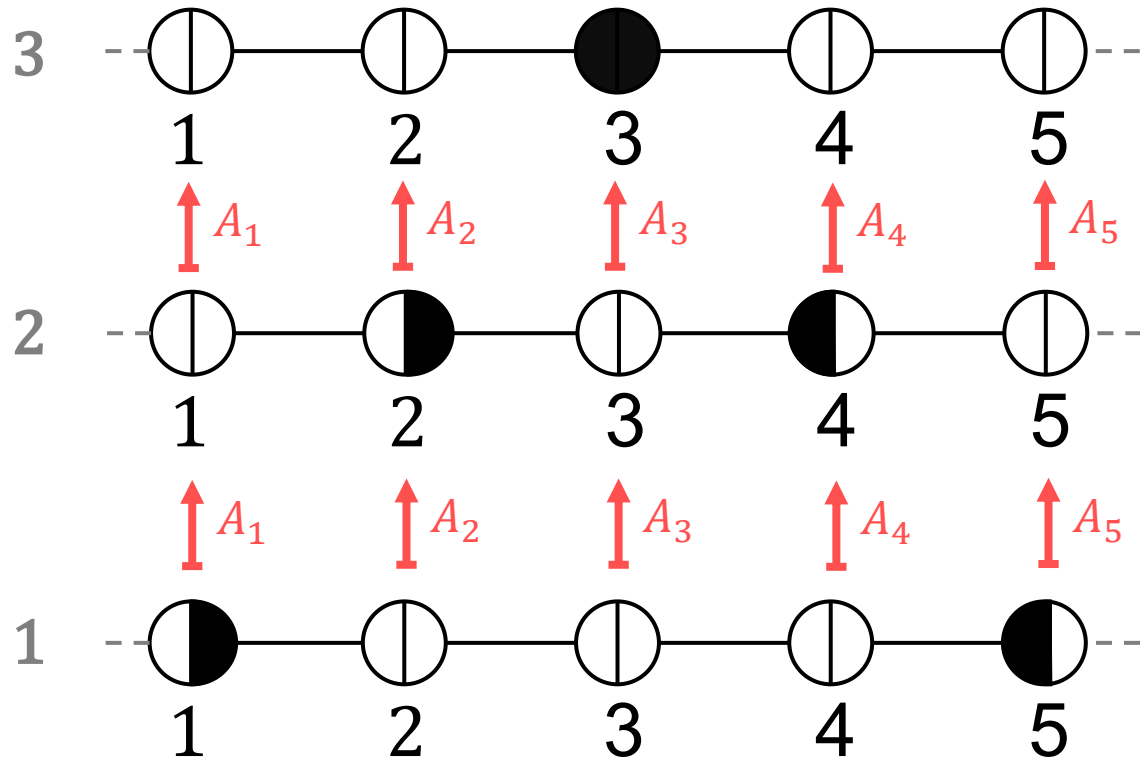

Local rule

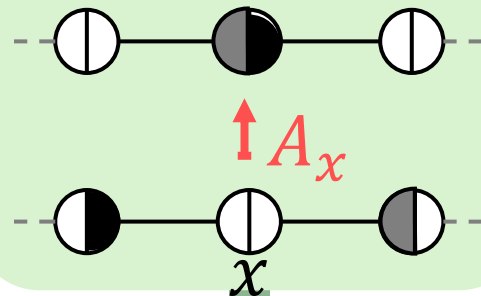

**Graph rewriting
(Asynchronous)**

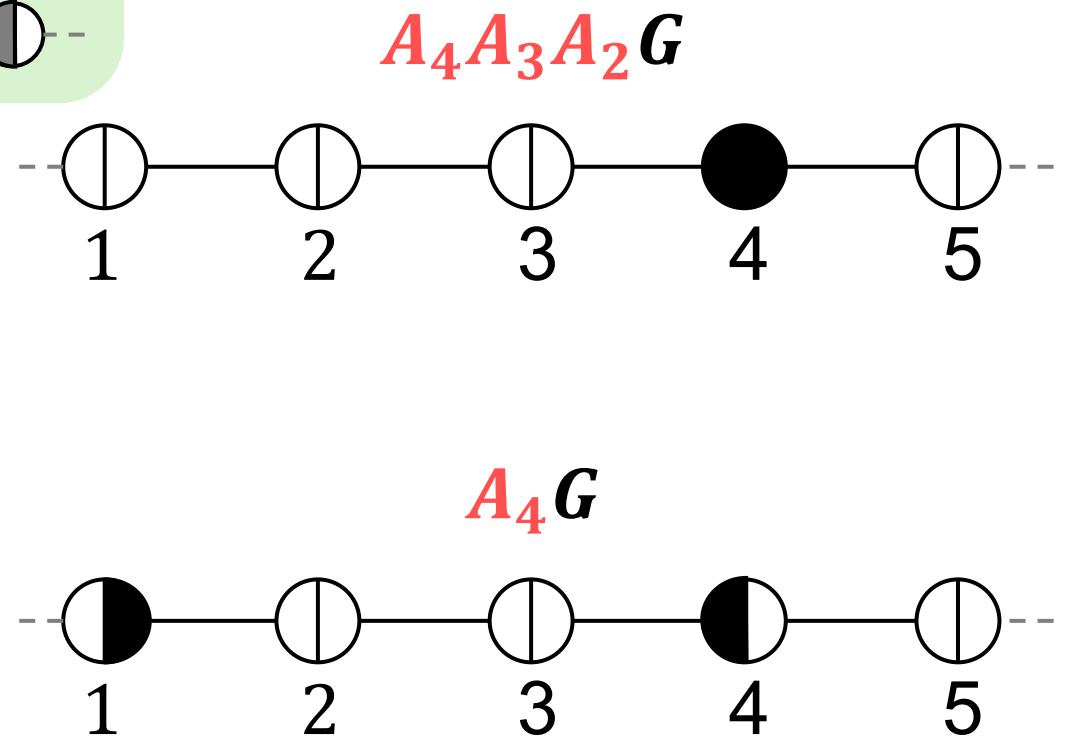

Dynamical systems and rewriting

**Dynamical system
(Synchronous)**

time

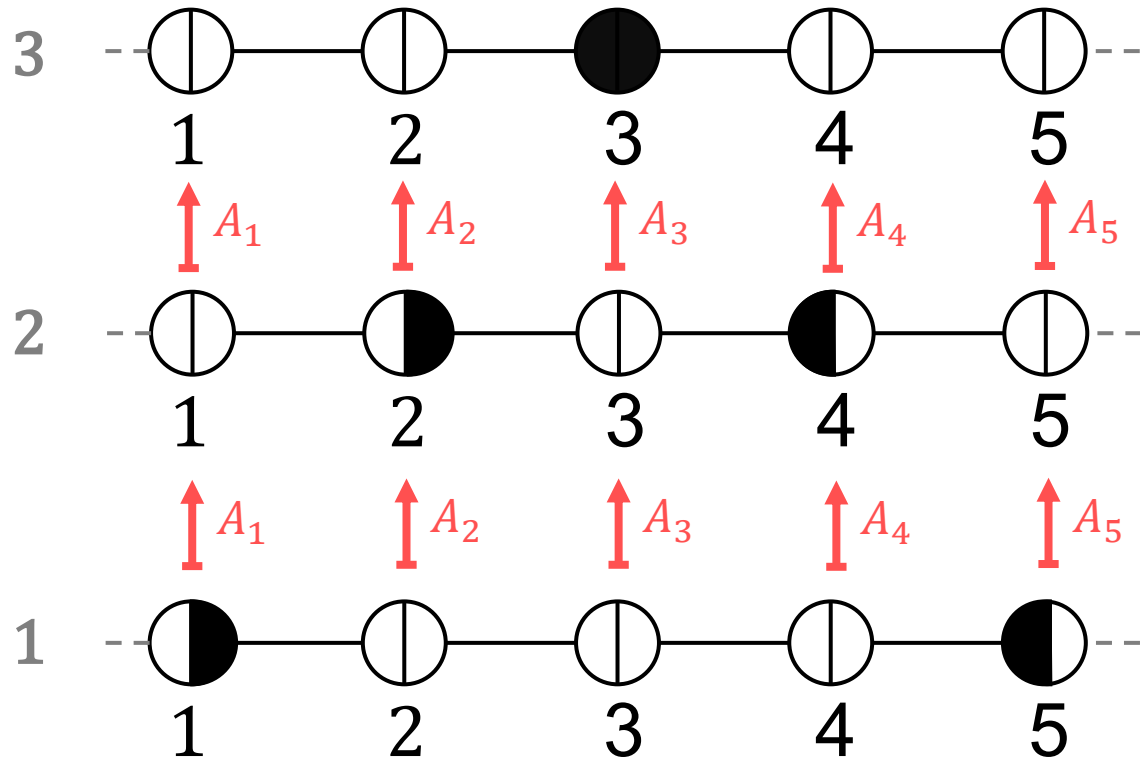

Local rule

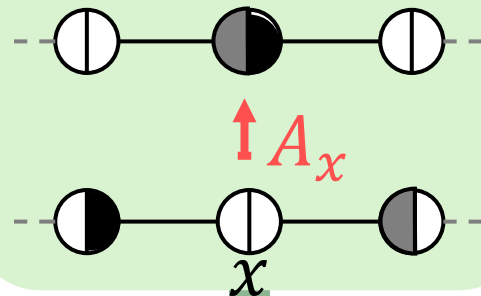

**Graph rewriting
(Asynchronous)**

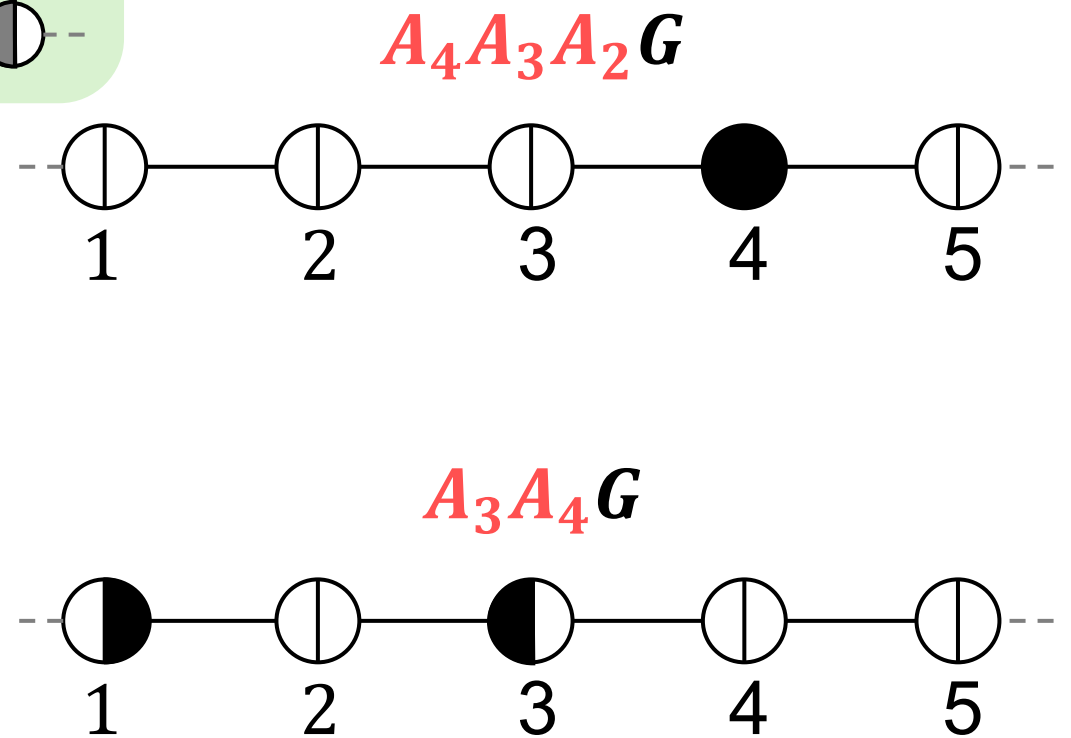

Dynamical systems and rewriting

**Dynamical system
(Synchronous)**

time

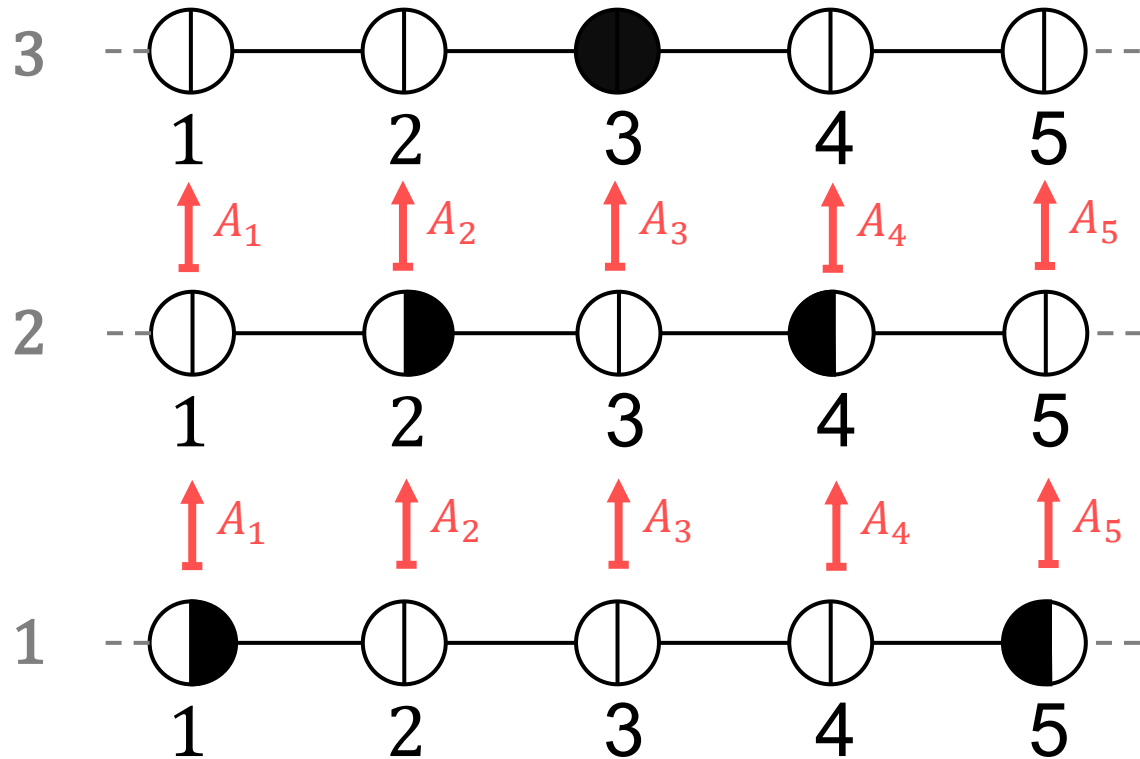

Local rule

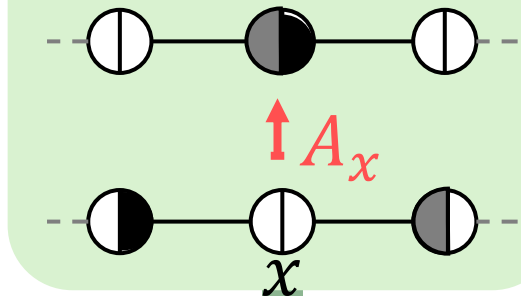

**Graph rewriting
(Asynchronous)**

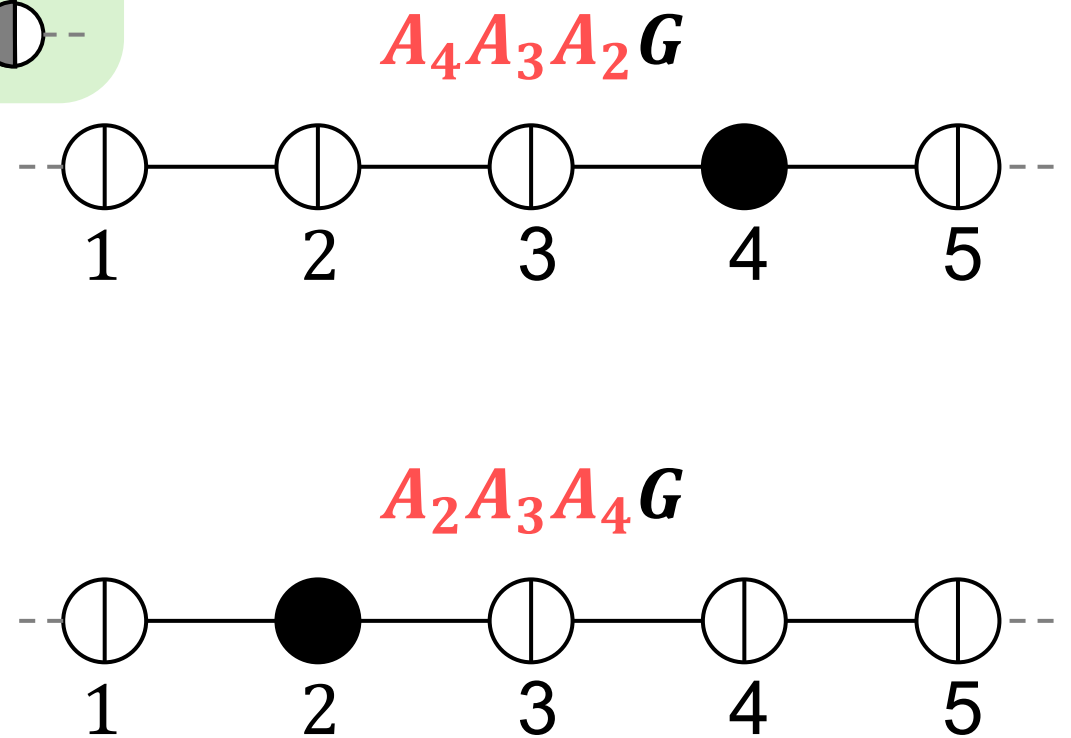

Dynamical systems and rewriting

Dynamical system (Synchronous)

time

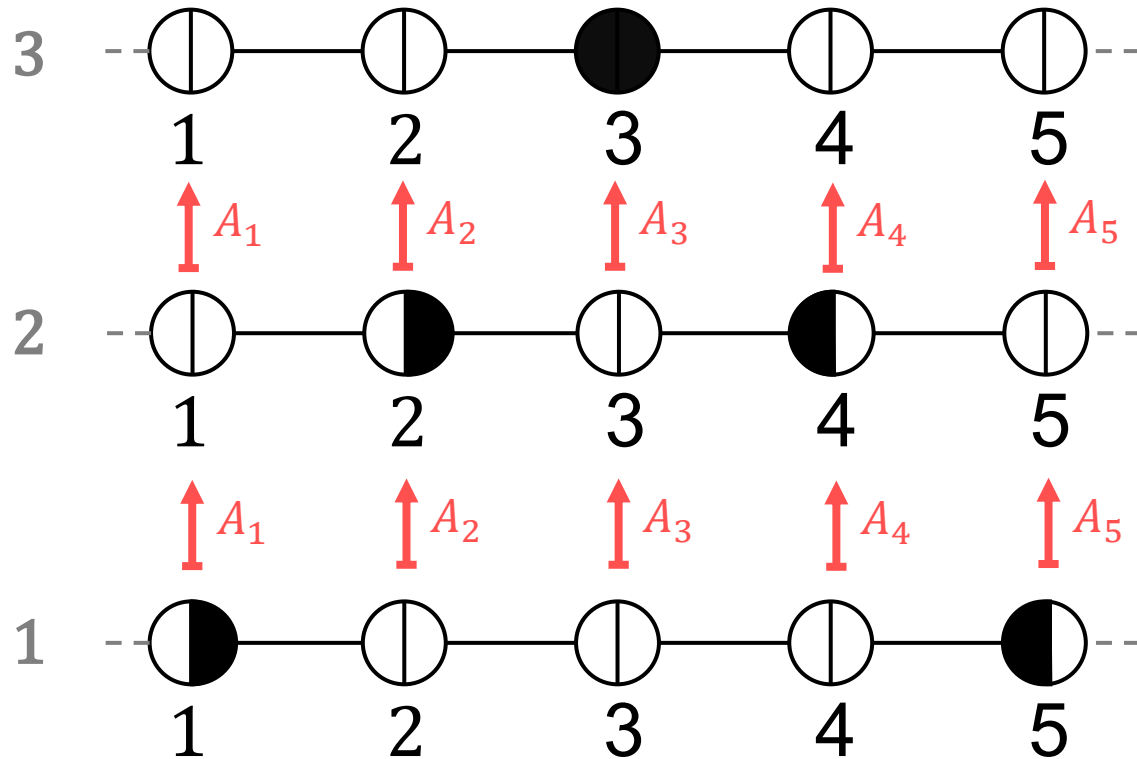

Naive asynchronous counterpart

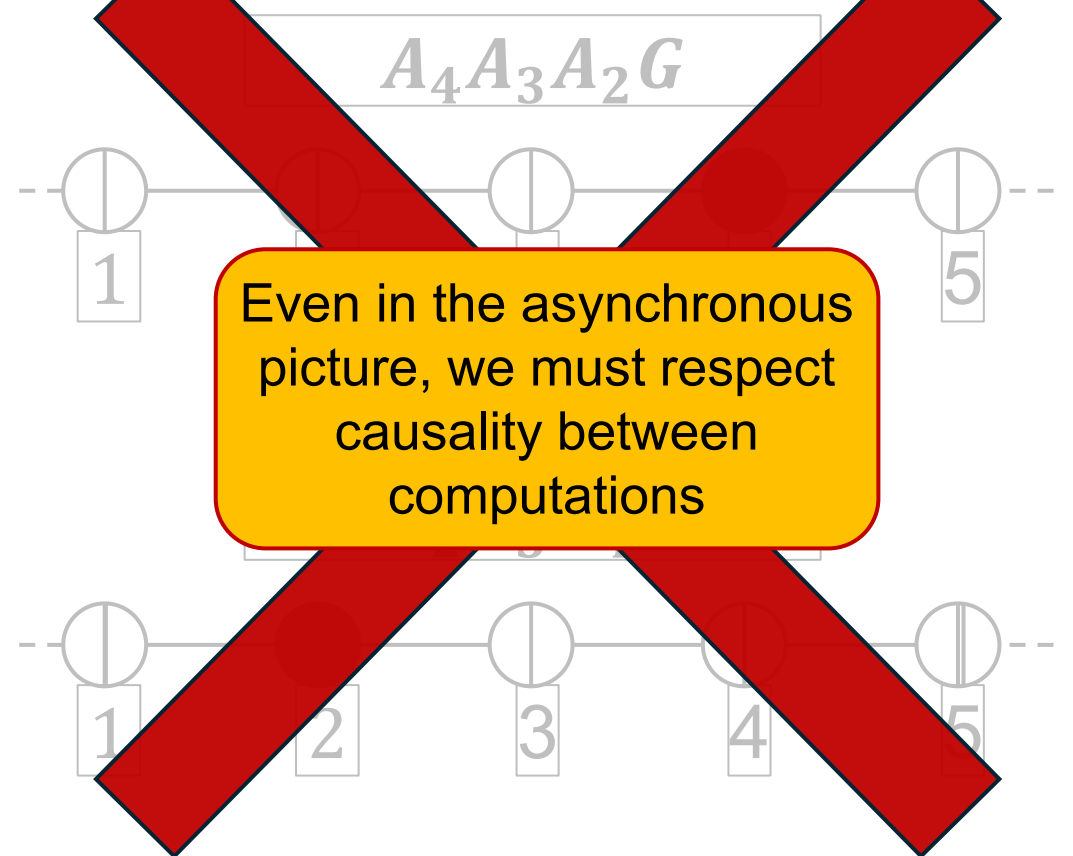

Dynamical systems and rewriting

Causal structure

time

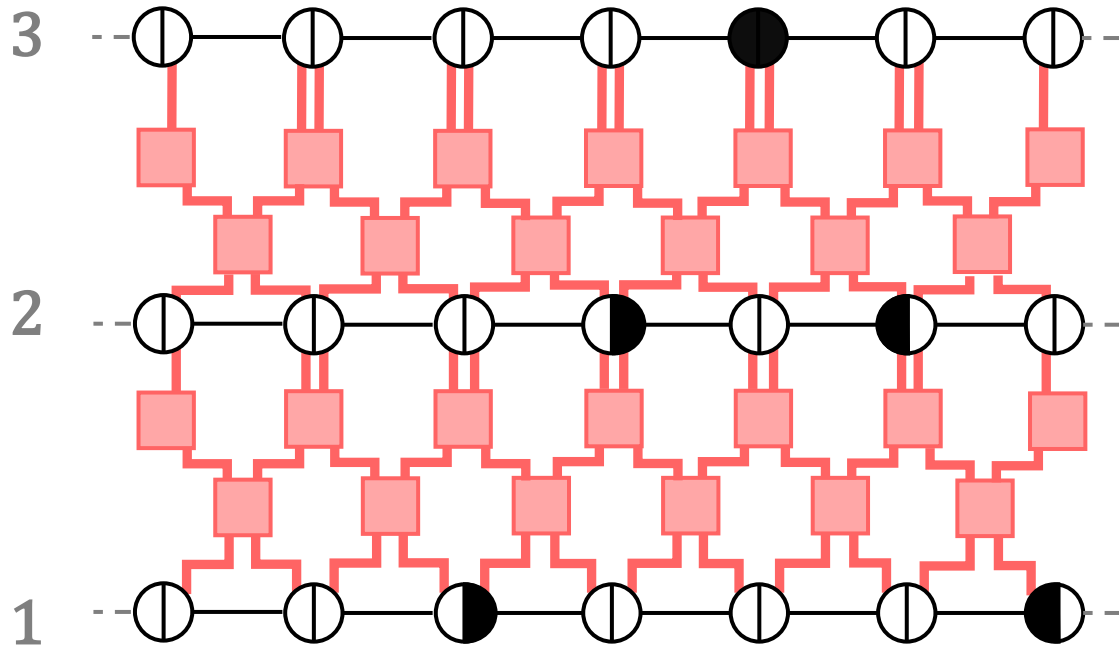

Naive asynchronous counterpart

$A_4 A_3 A_2 G$

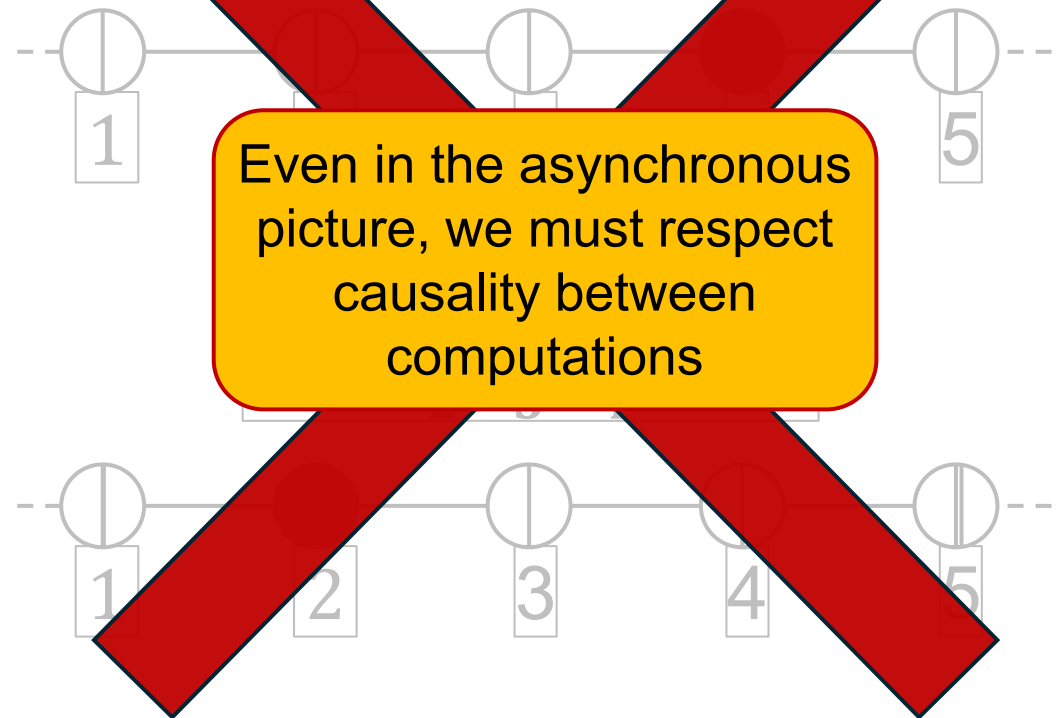

Dynamical systems and rewriting

Causal structure

time

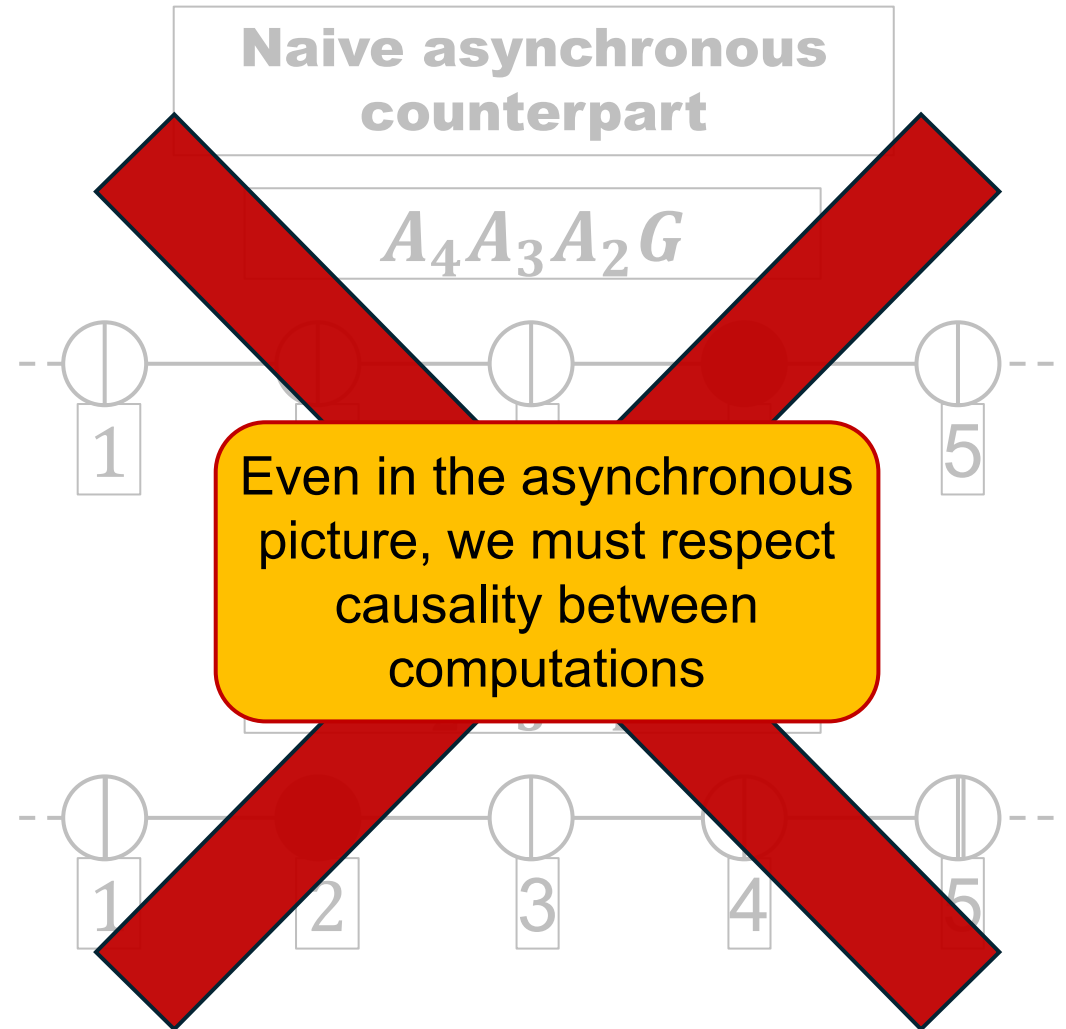
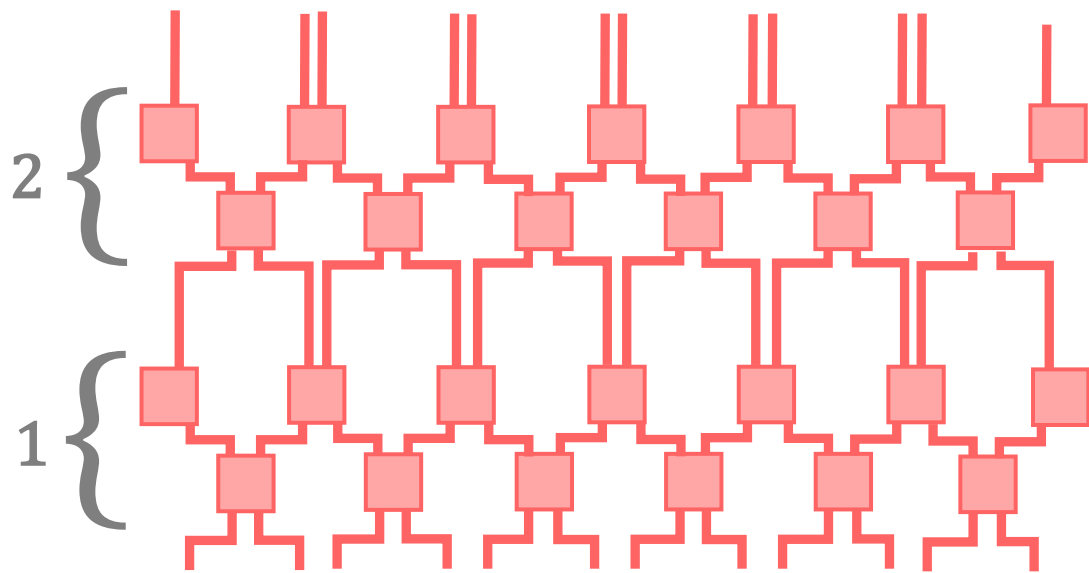

Dynamical systems and rewriting

Causal structure

time

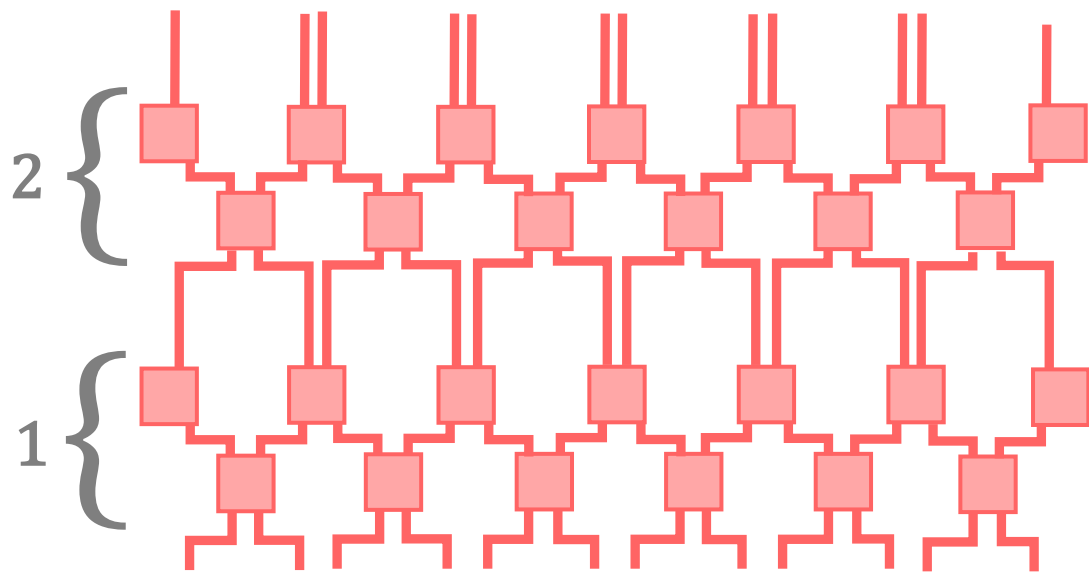

Causal graph rewriting

time

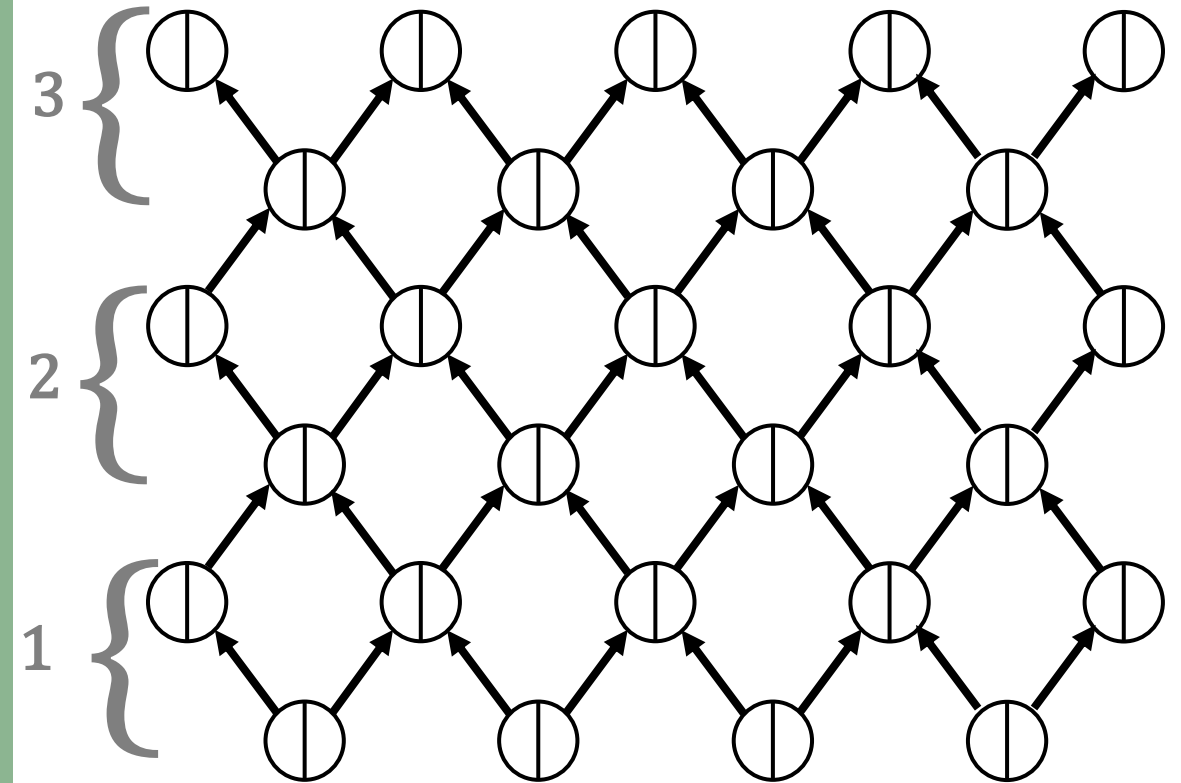

Dynamical systems and rewriting

Causal structure

time

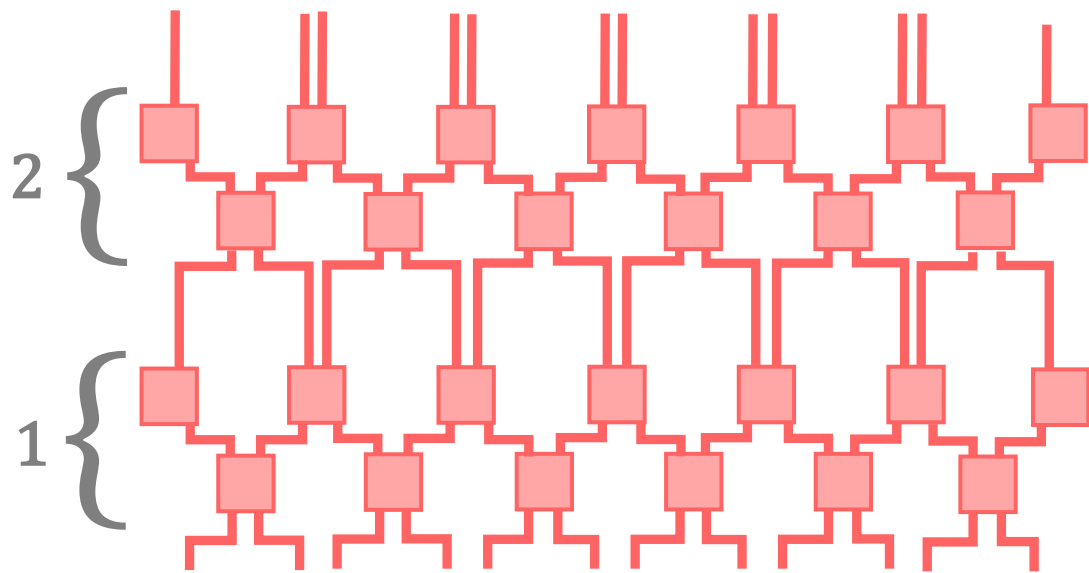

Causal graph rewriting

time

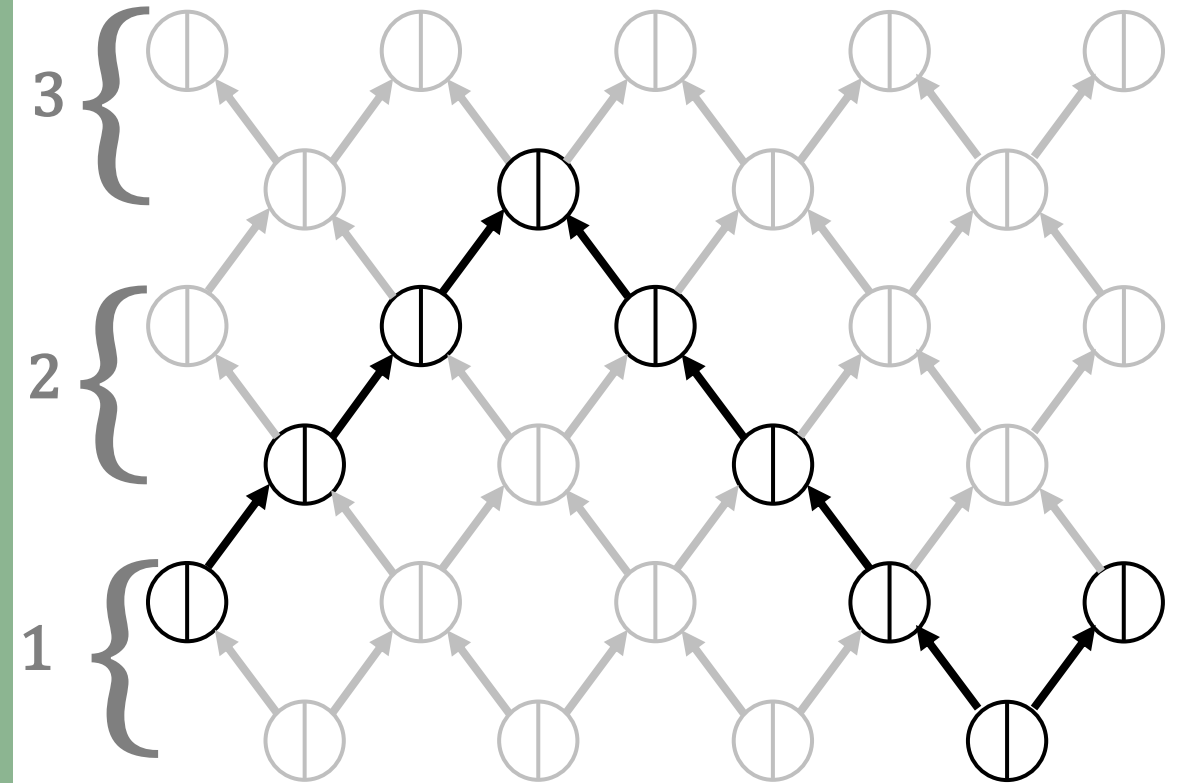

Dynamical systems and rewriting

Causal structure

time

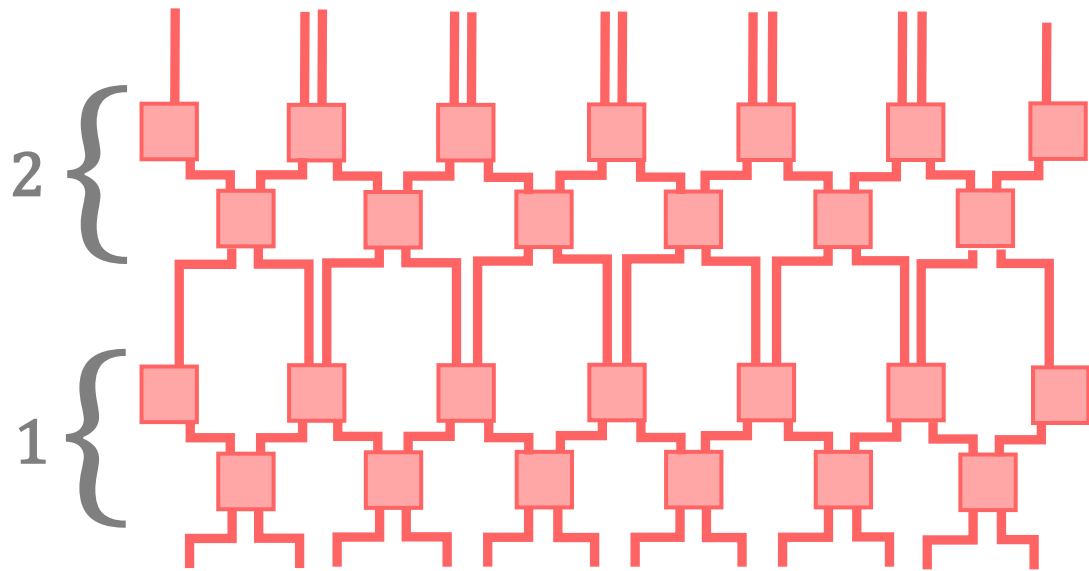

Causal graph rewriting

time

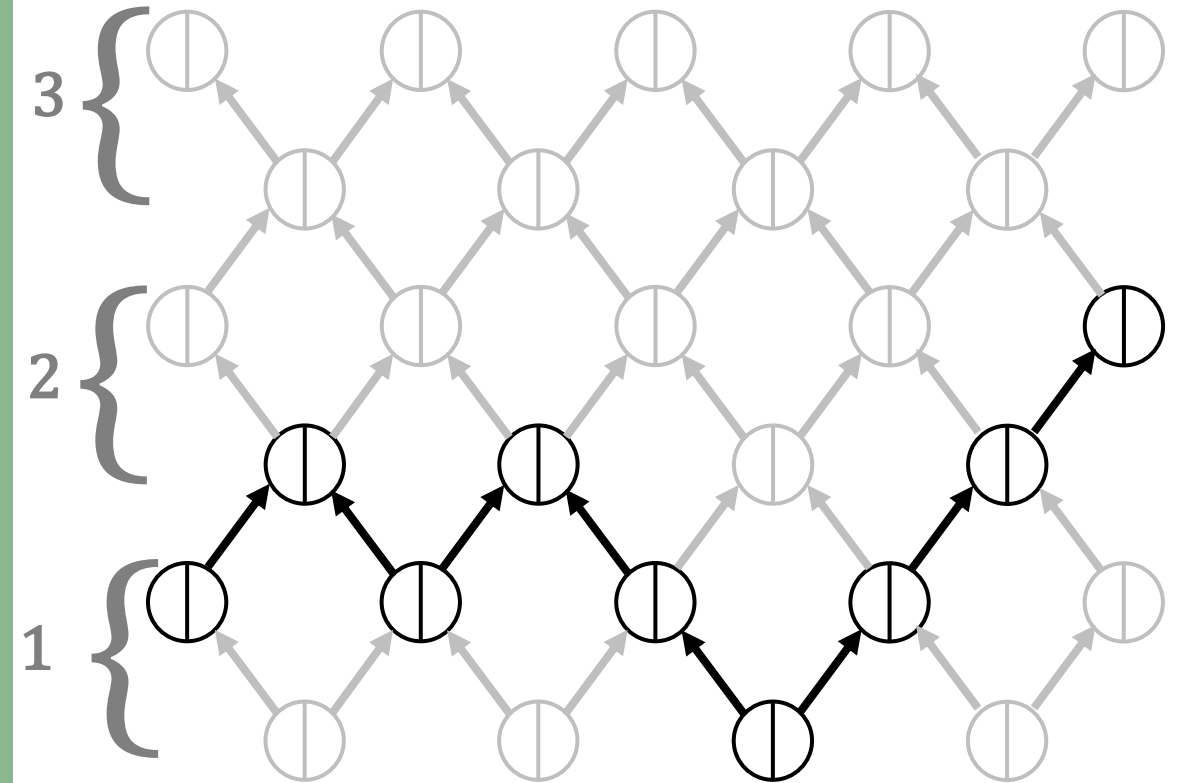

Dynamical systems and rewriting

Causal structure

time

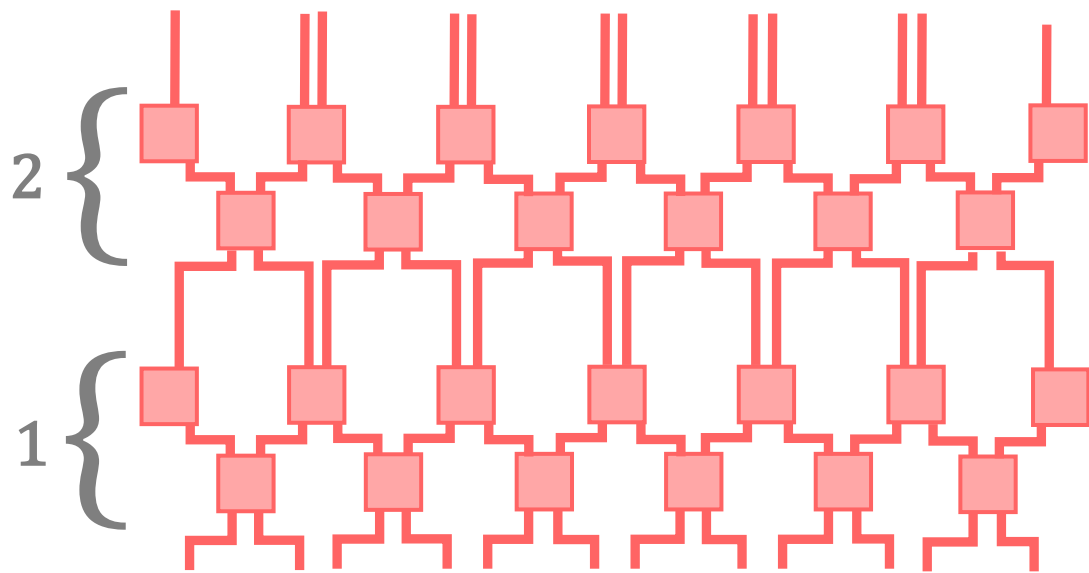

Causal graph rewriting

time

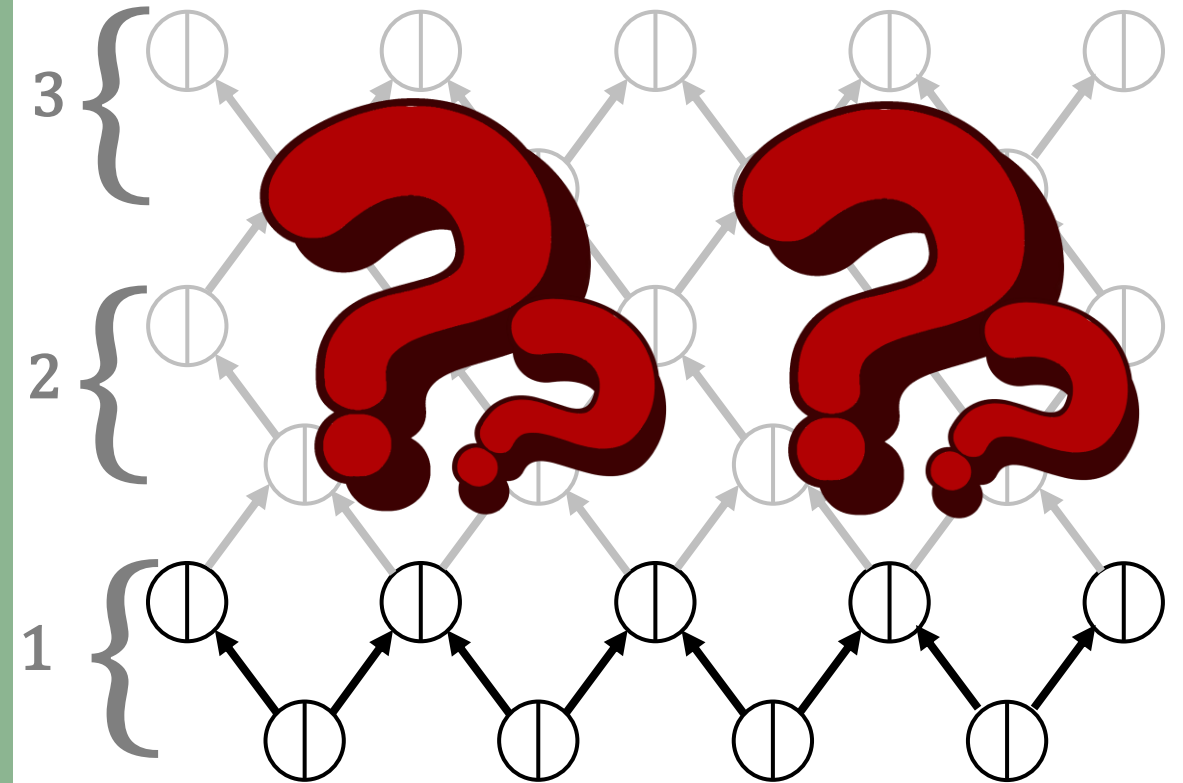

Particle system example

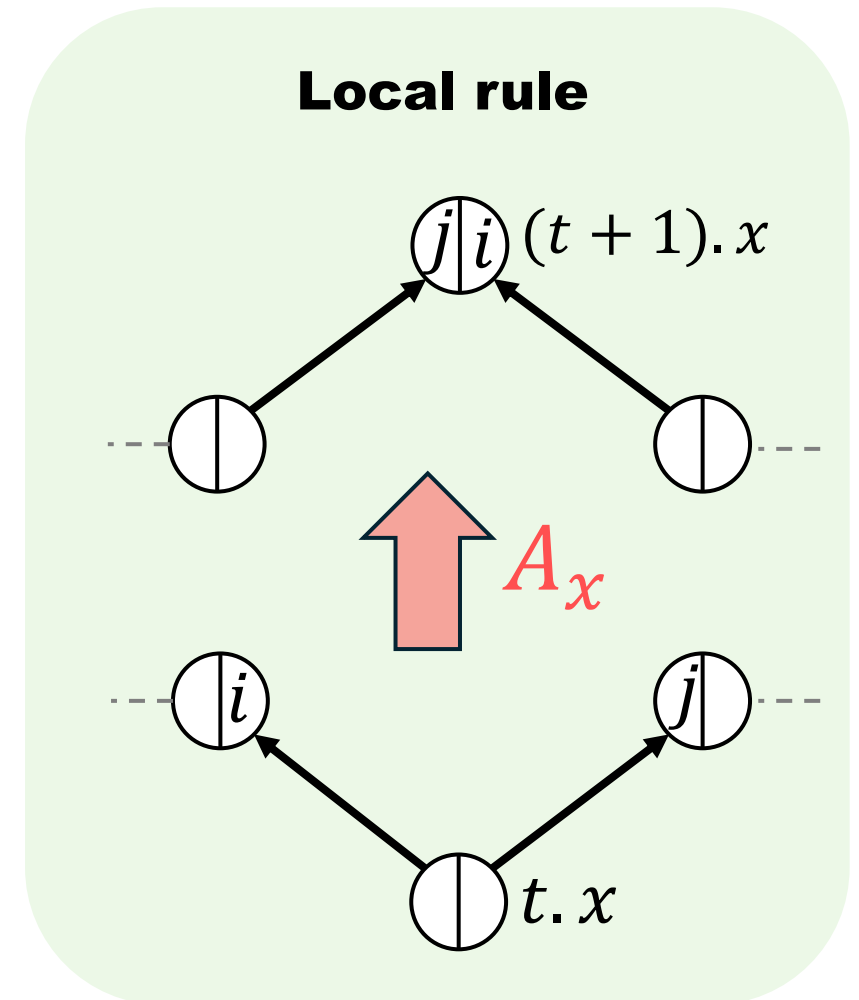
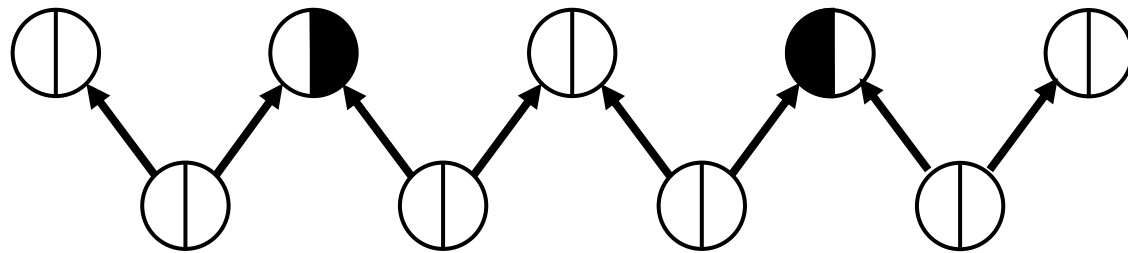

Particle system example

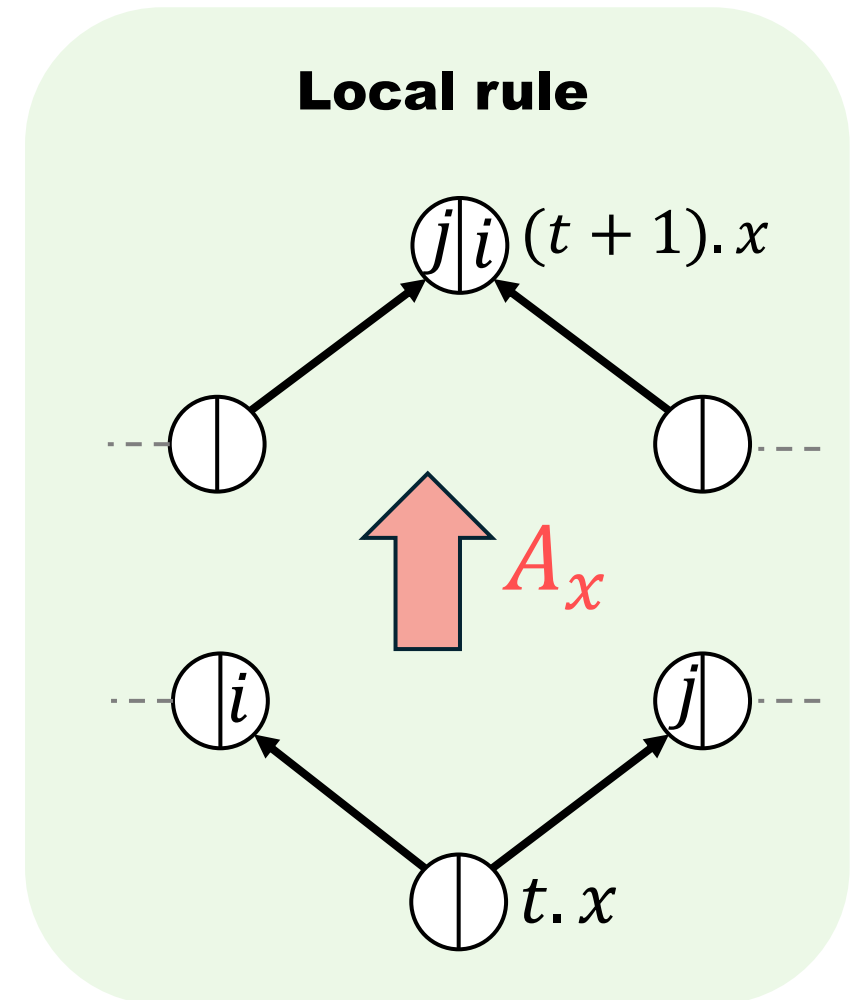
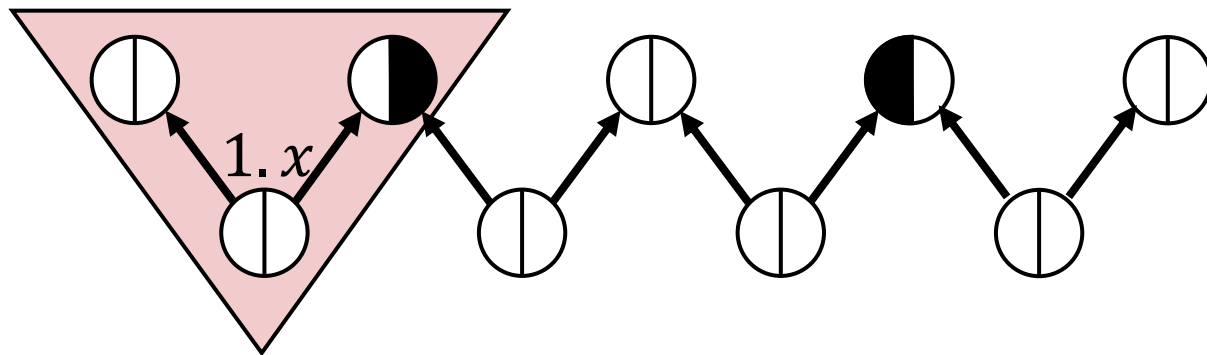

Particle system example

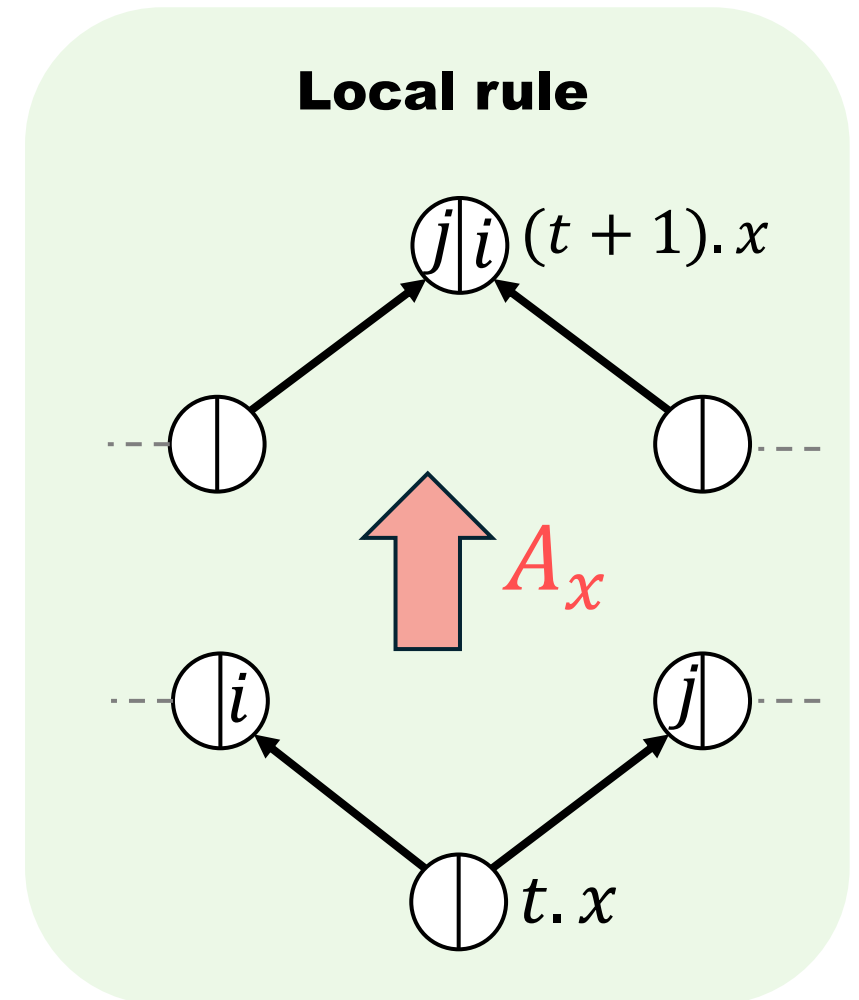
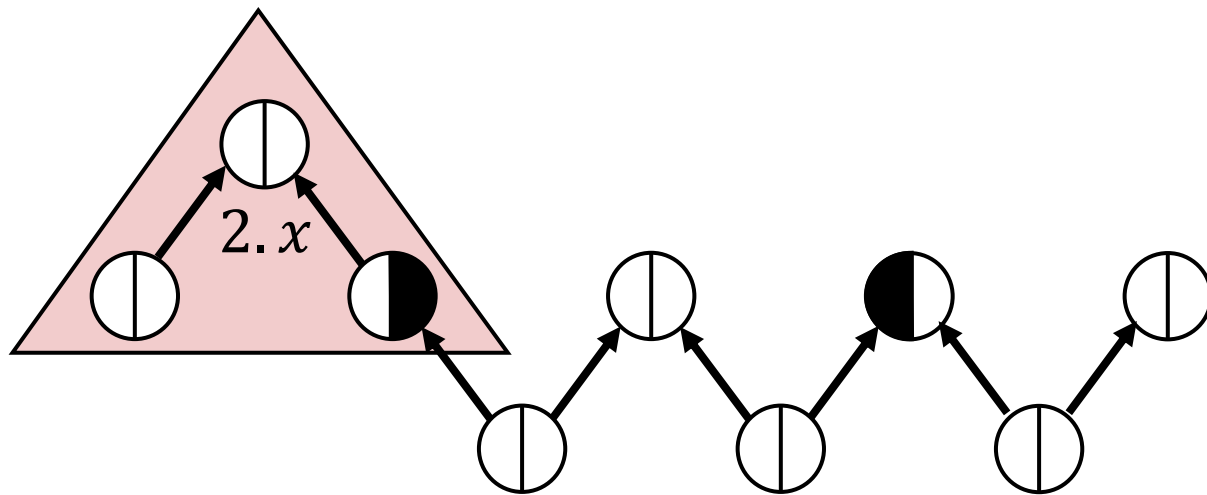

Particle system example

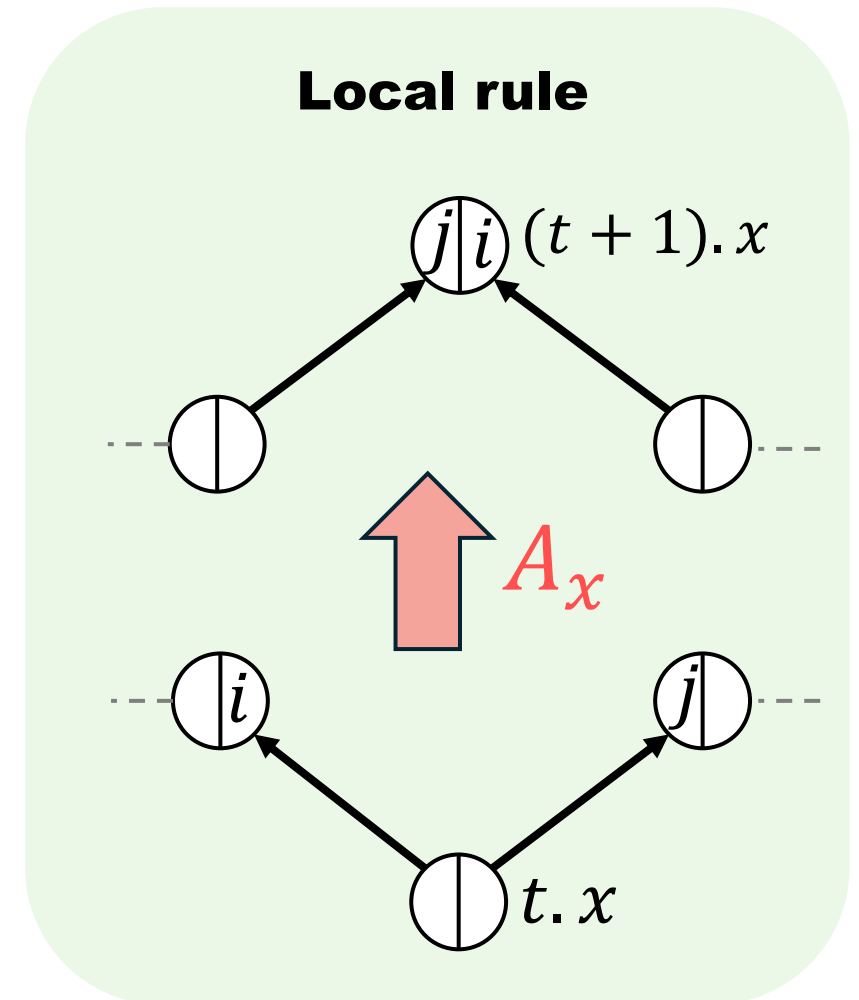
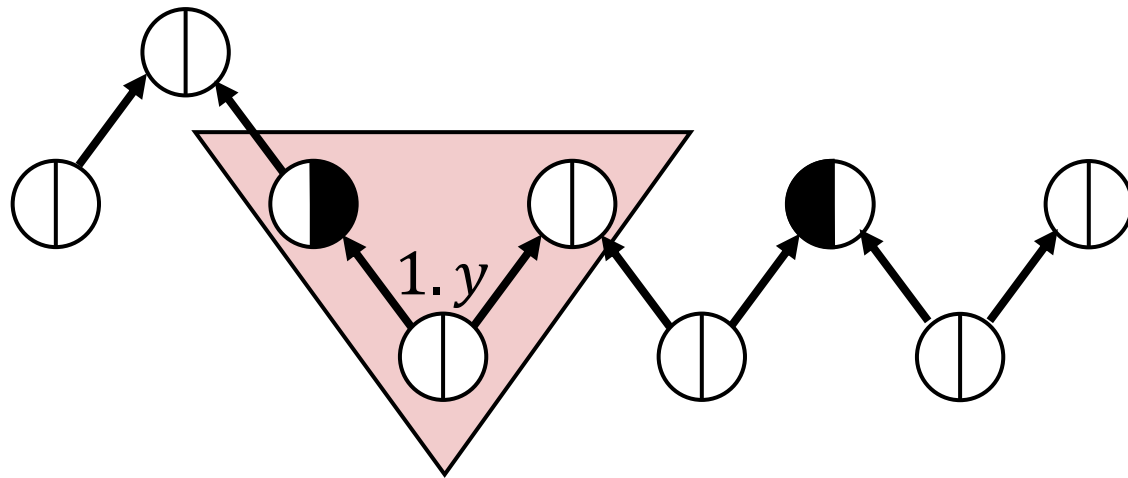

Particle system example

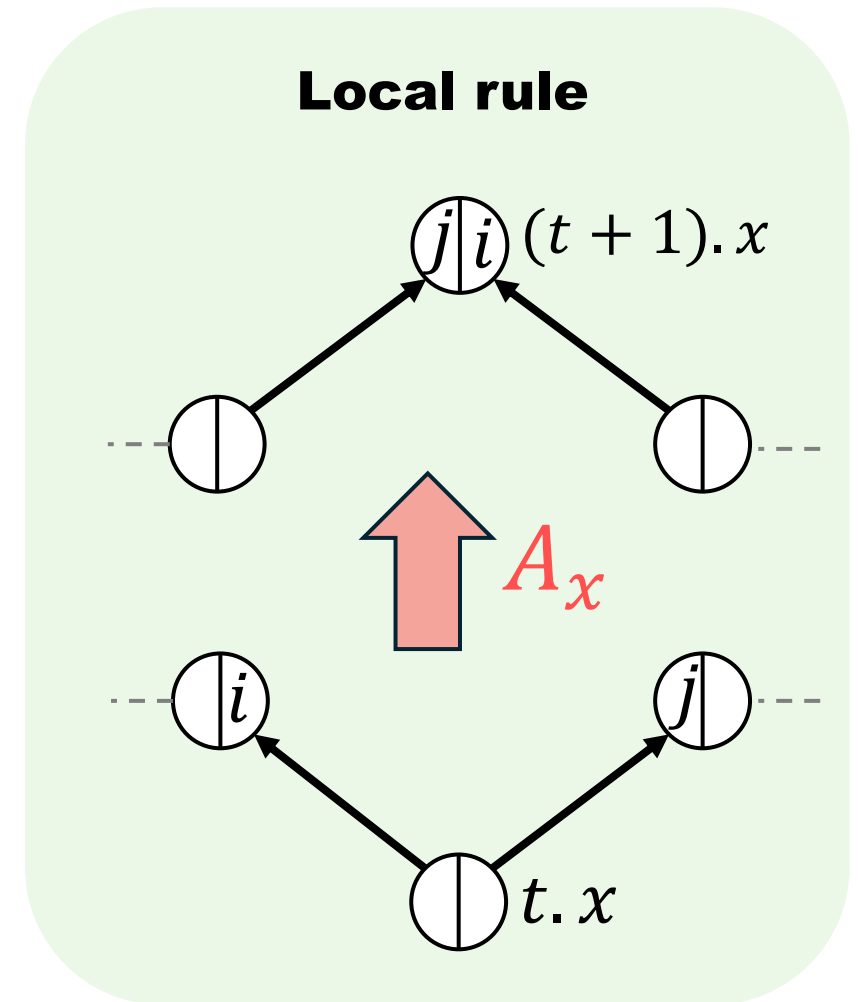
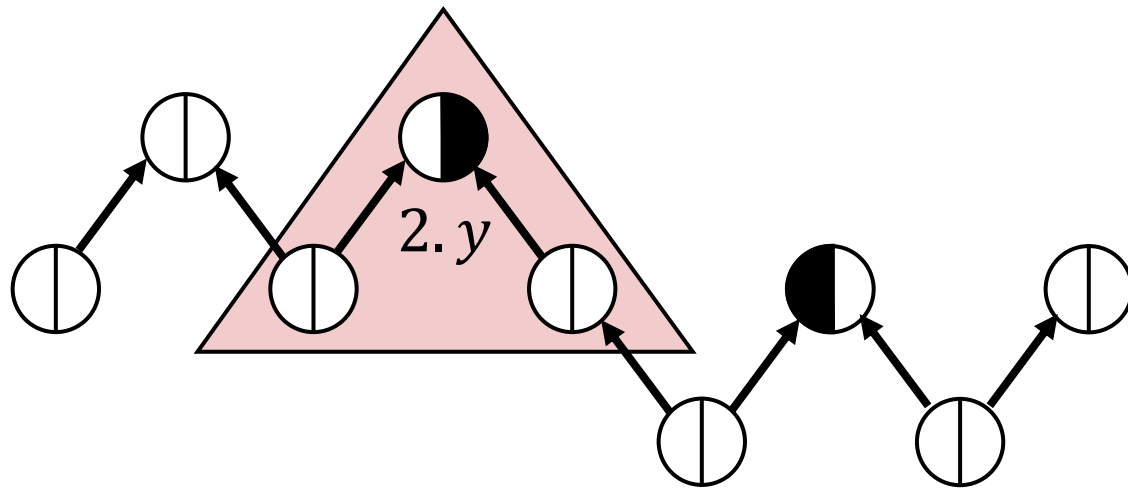

Particle system example

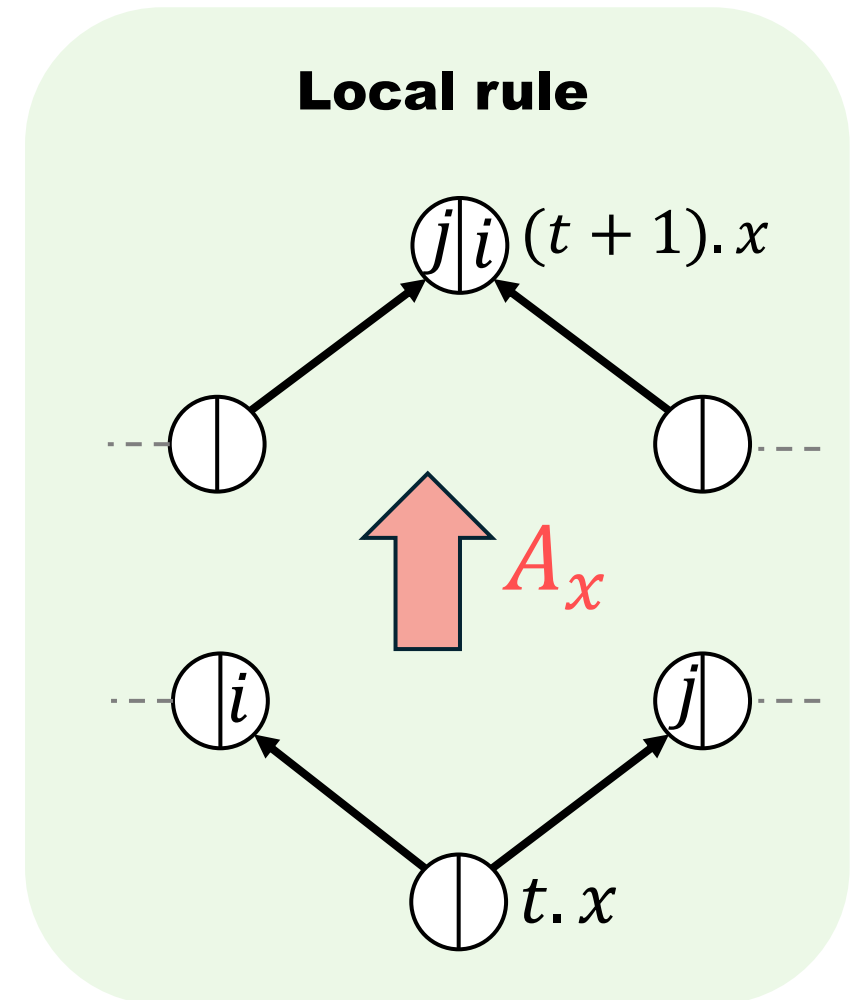
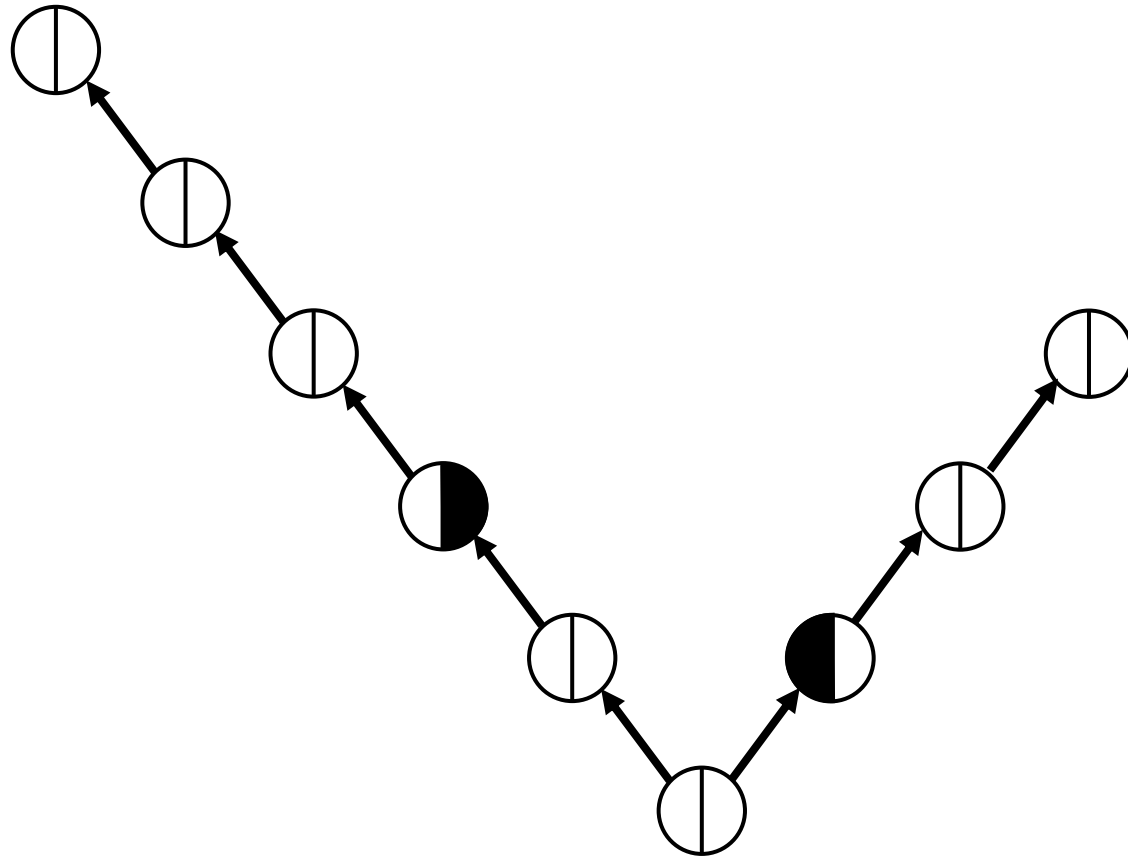

Particle system example

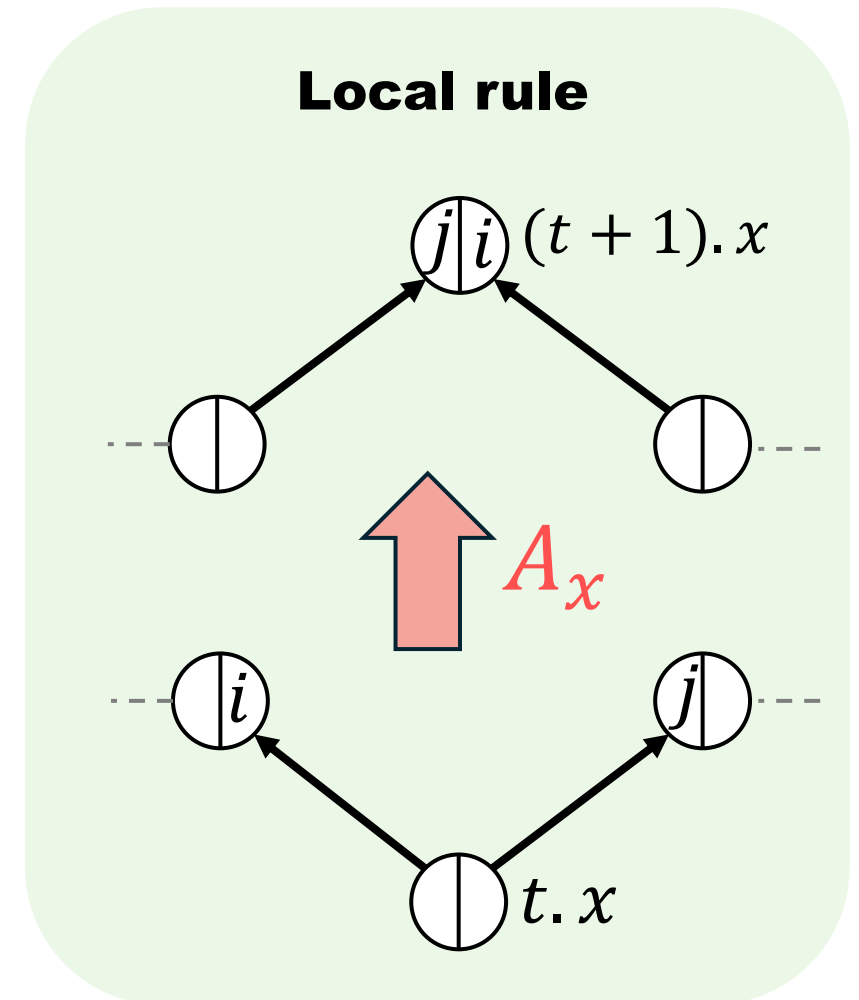
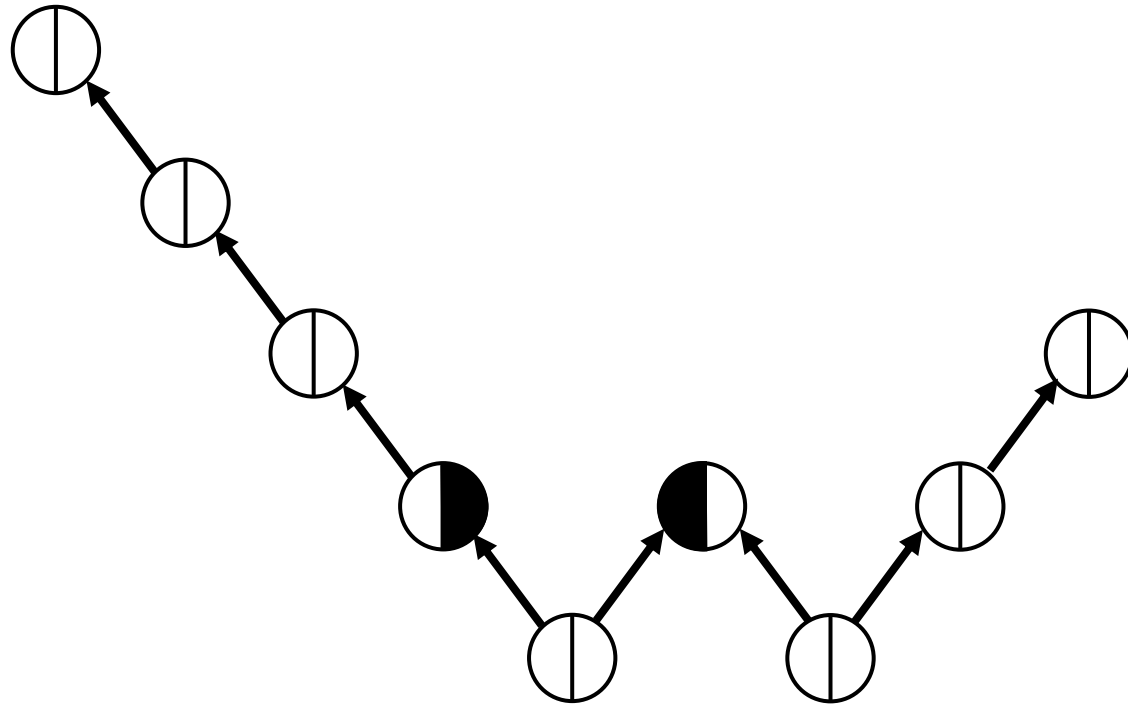

Particle system example

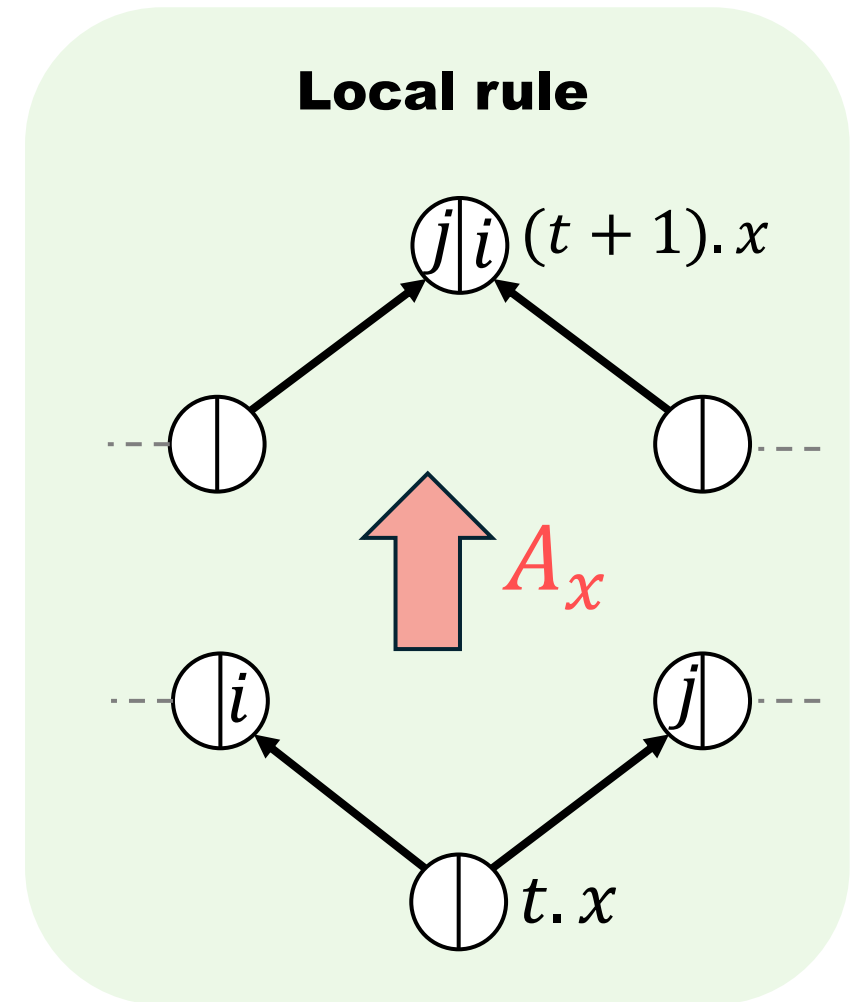
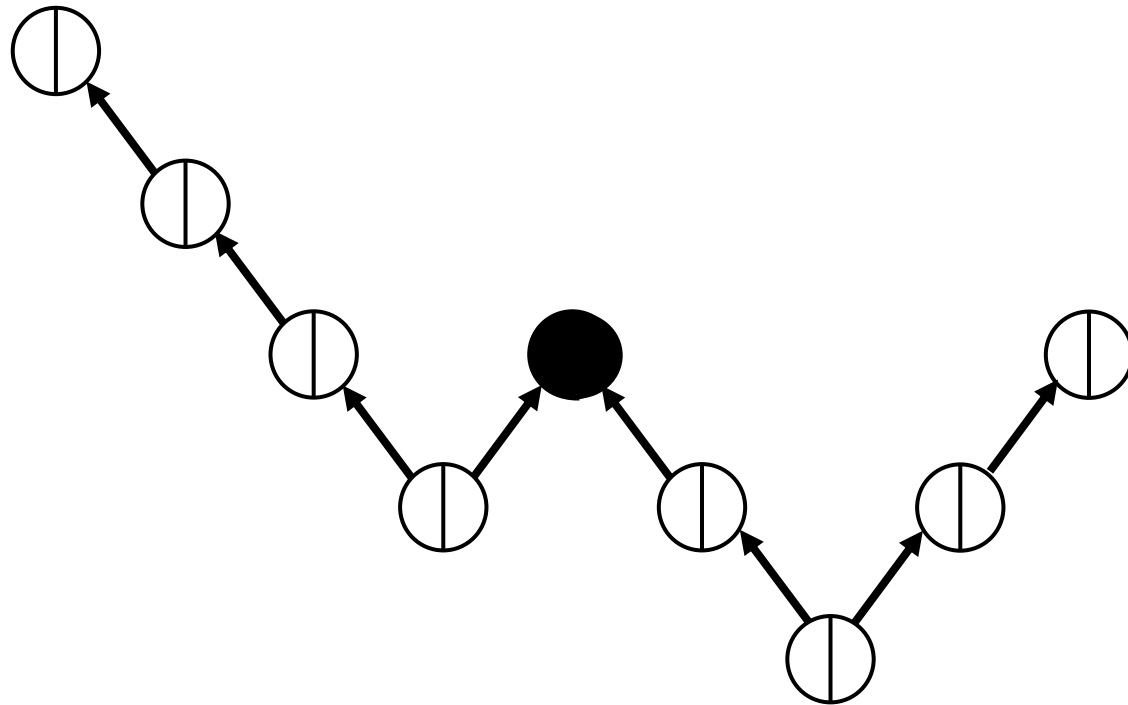

Particle system example

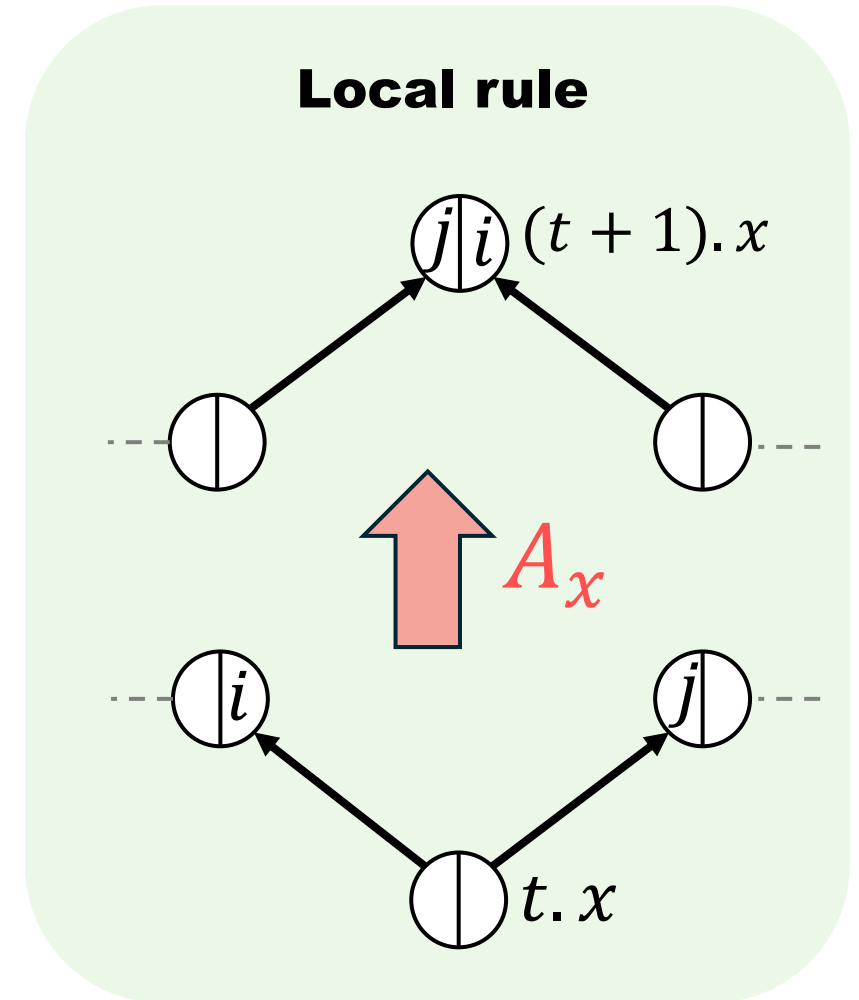
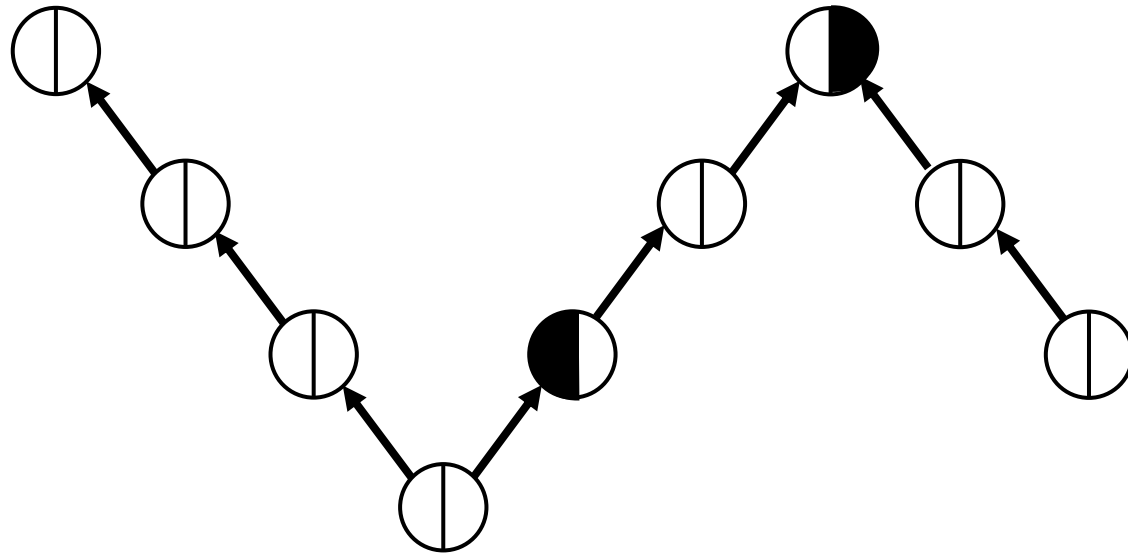

Particle system example

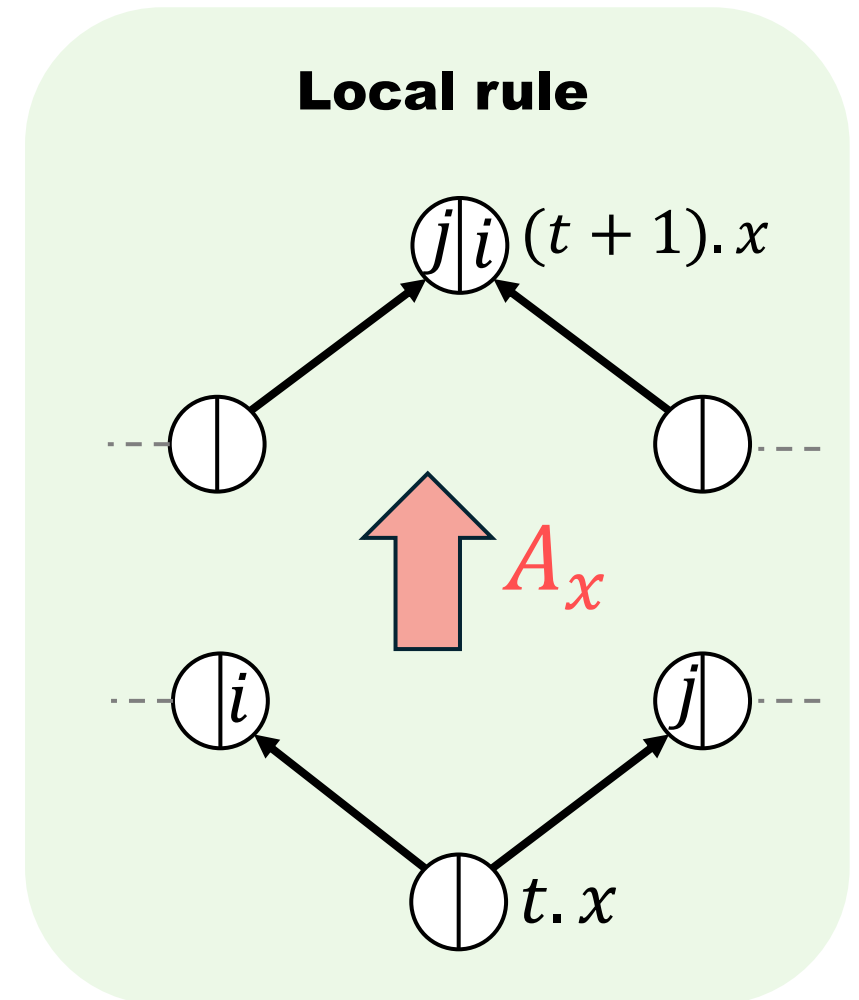
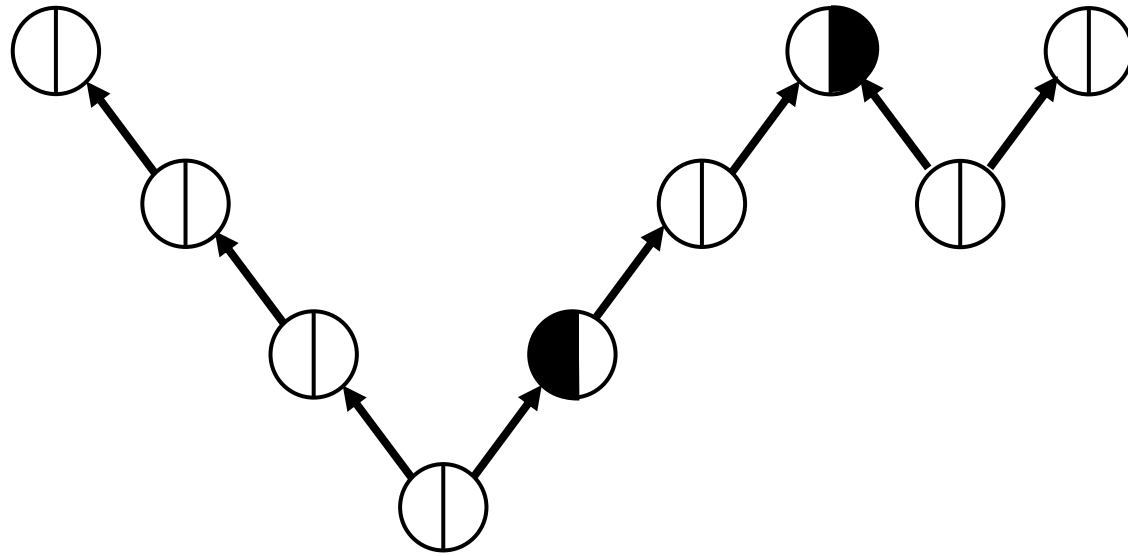

Particle system example

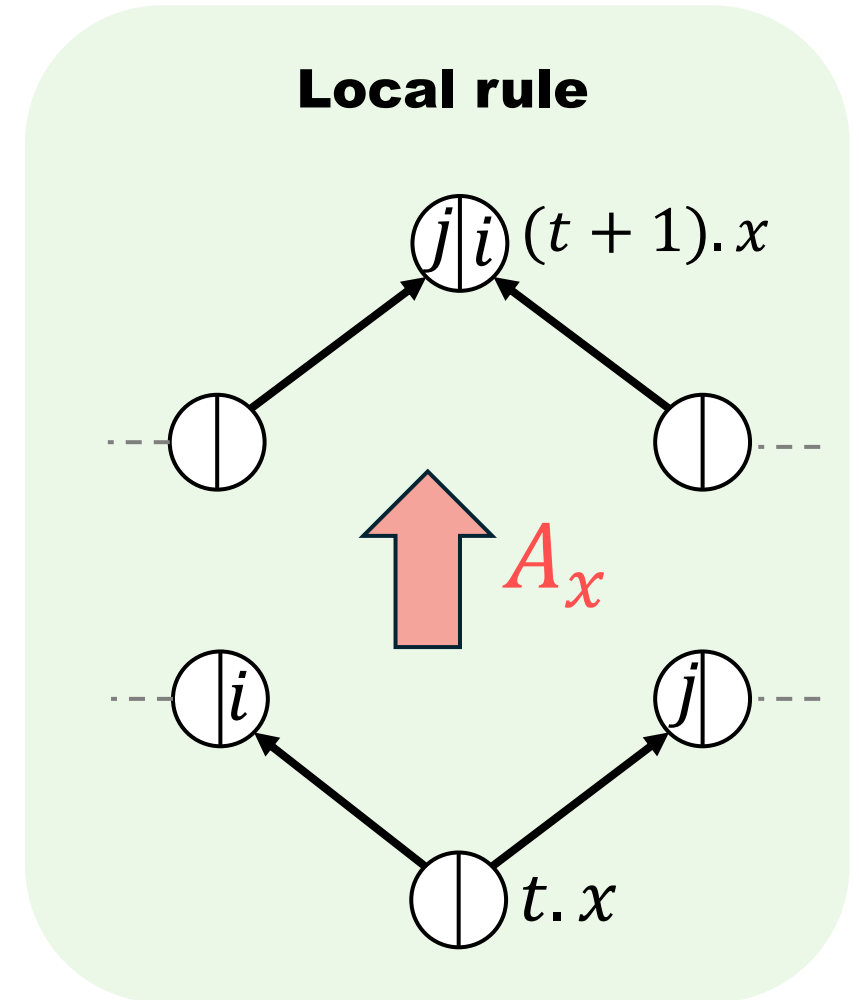
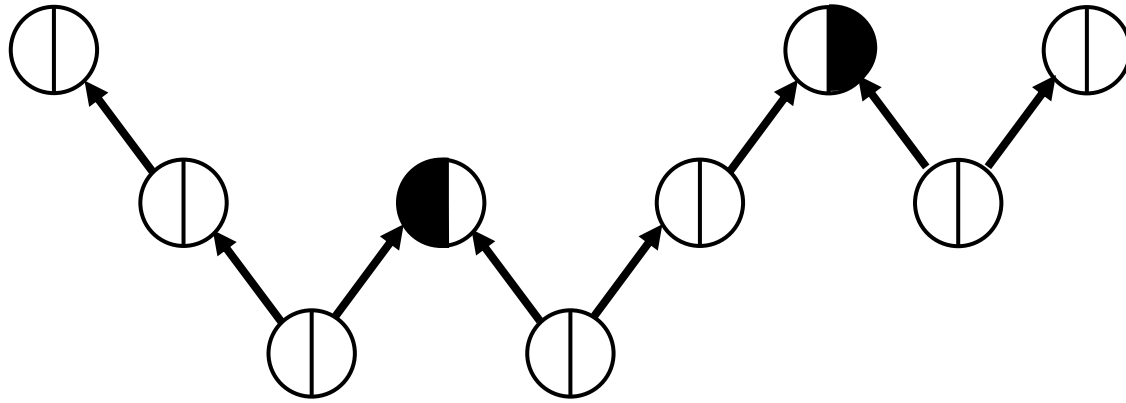

Particle system example

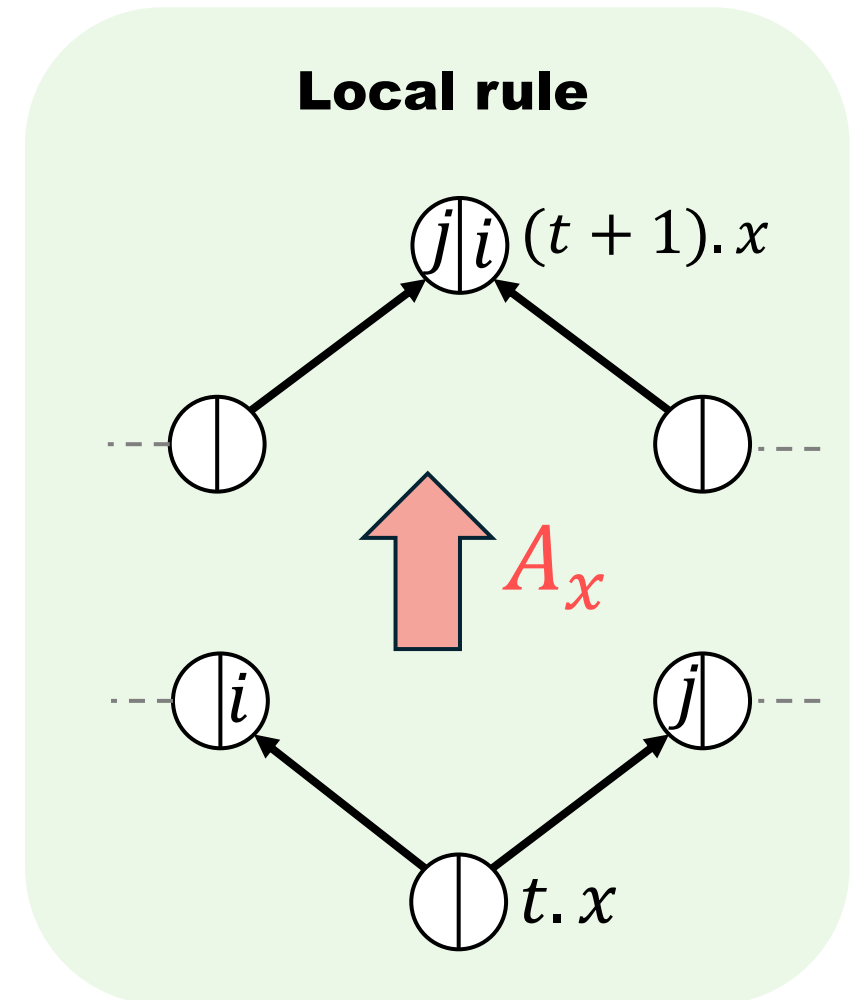
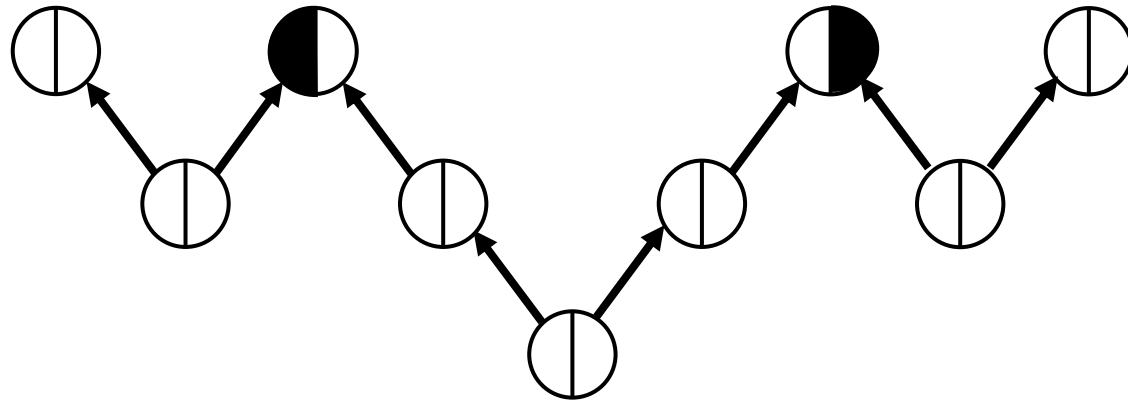

Particle system example

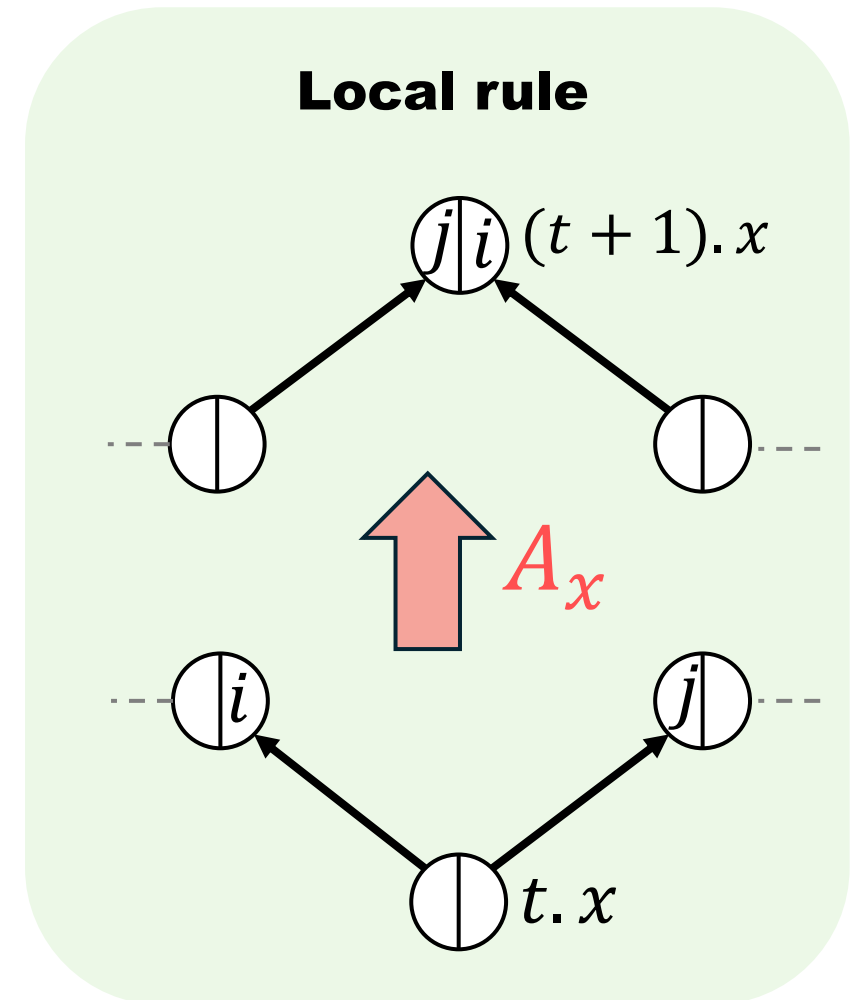
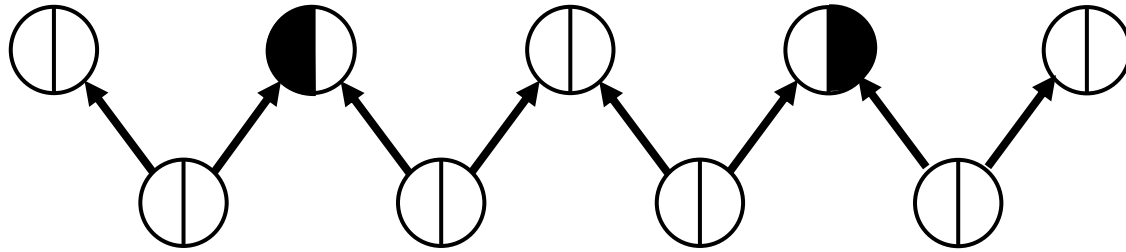

Particle system example

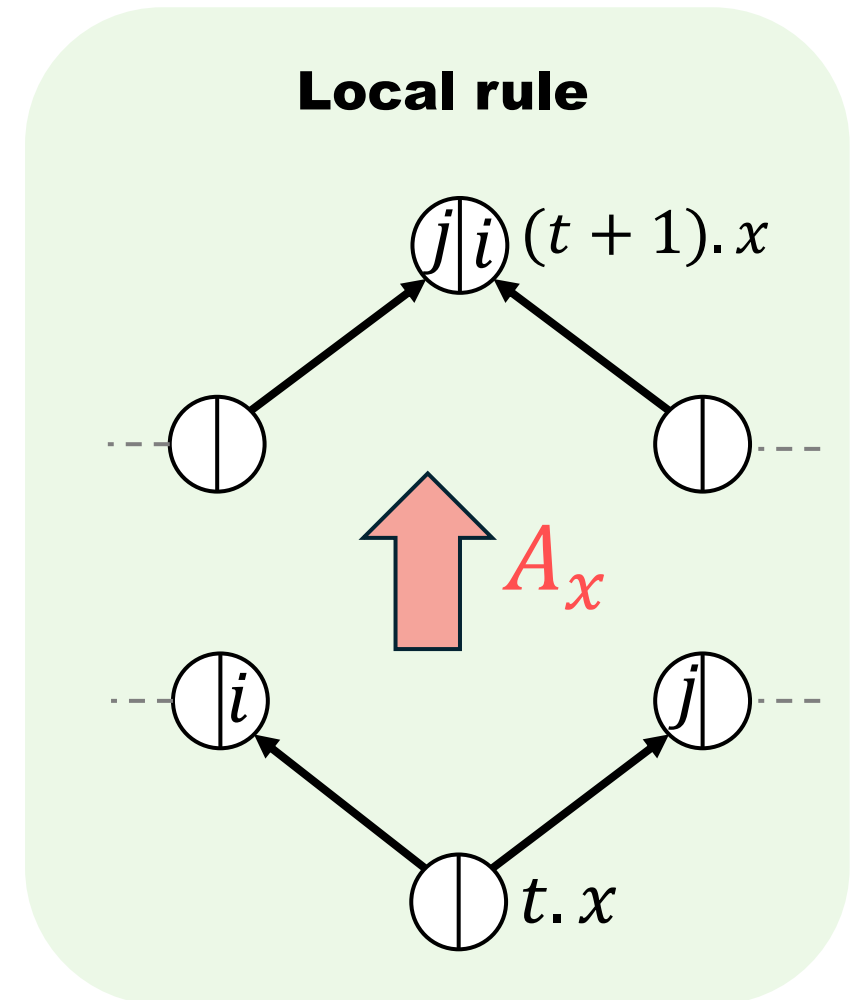
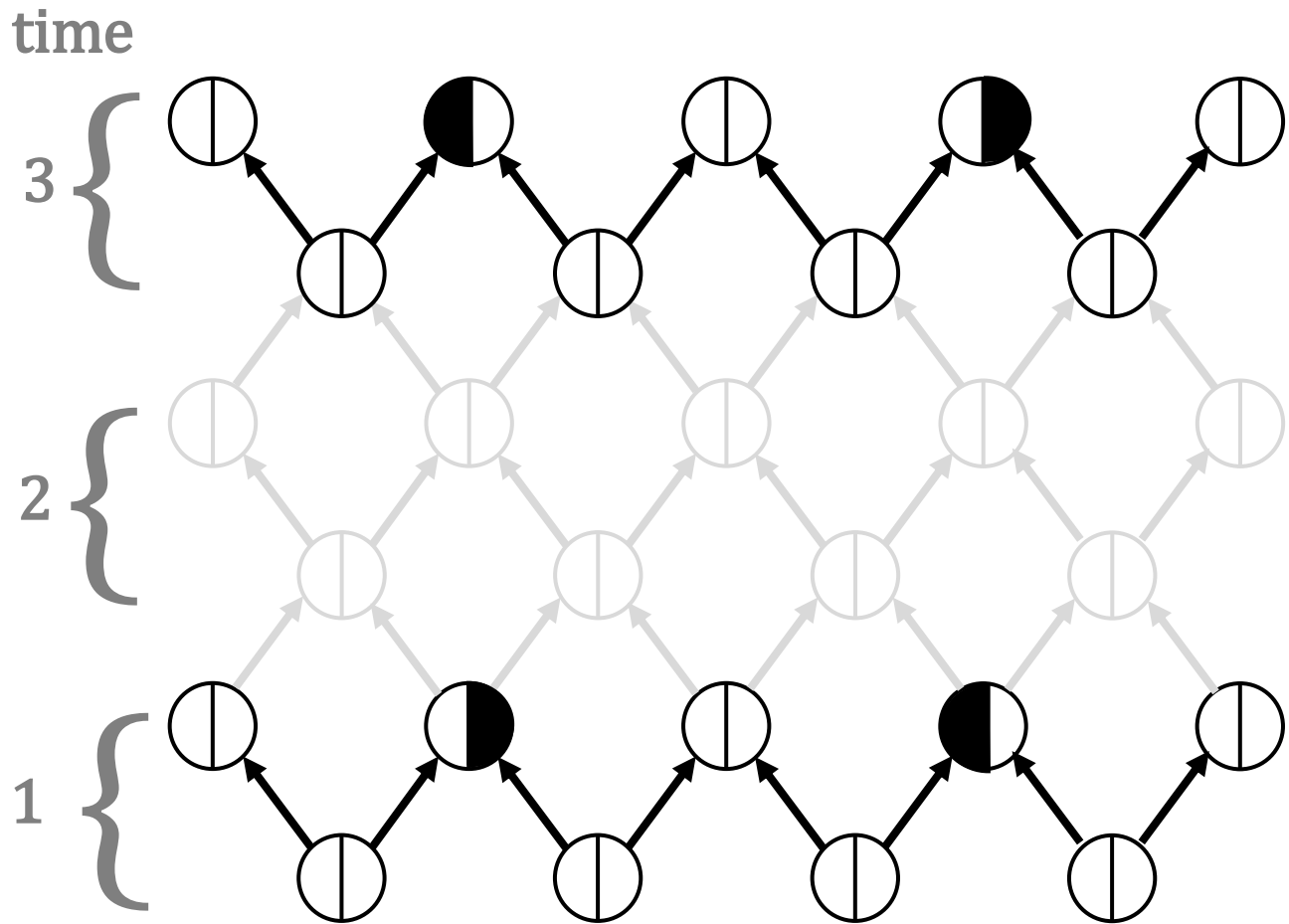

Time dilation example

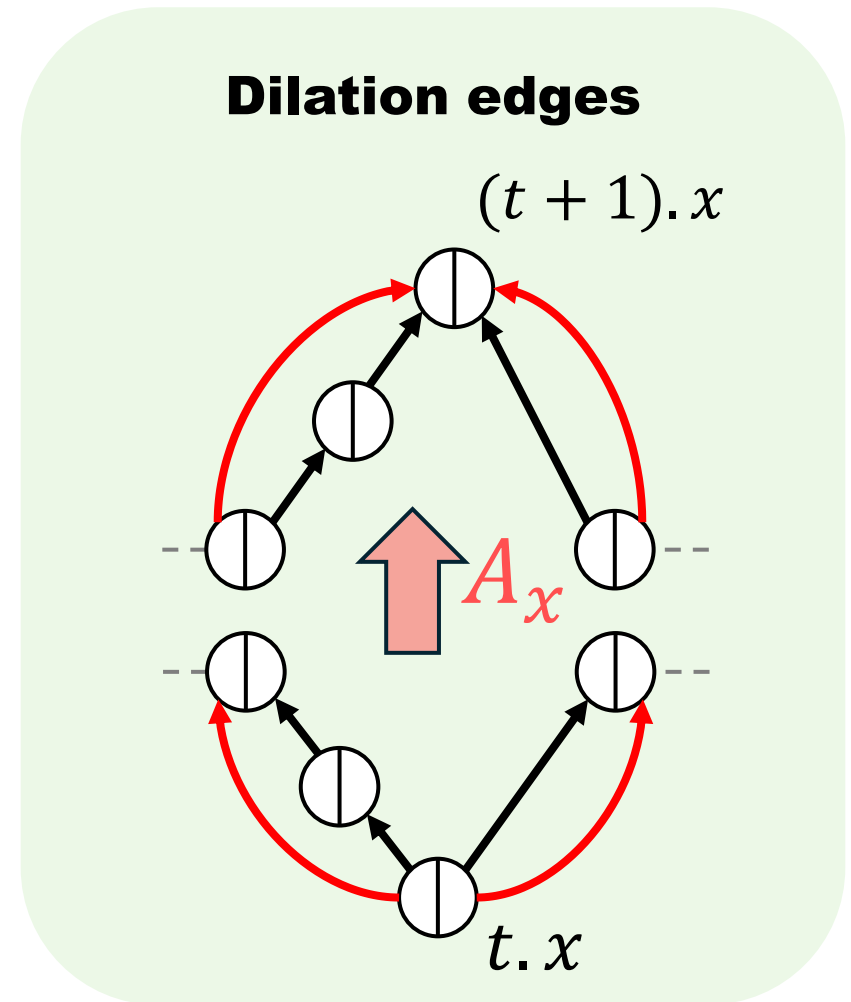
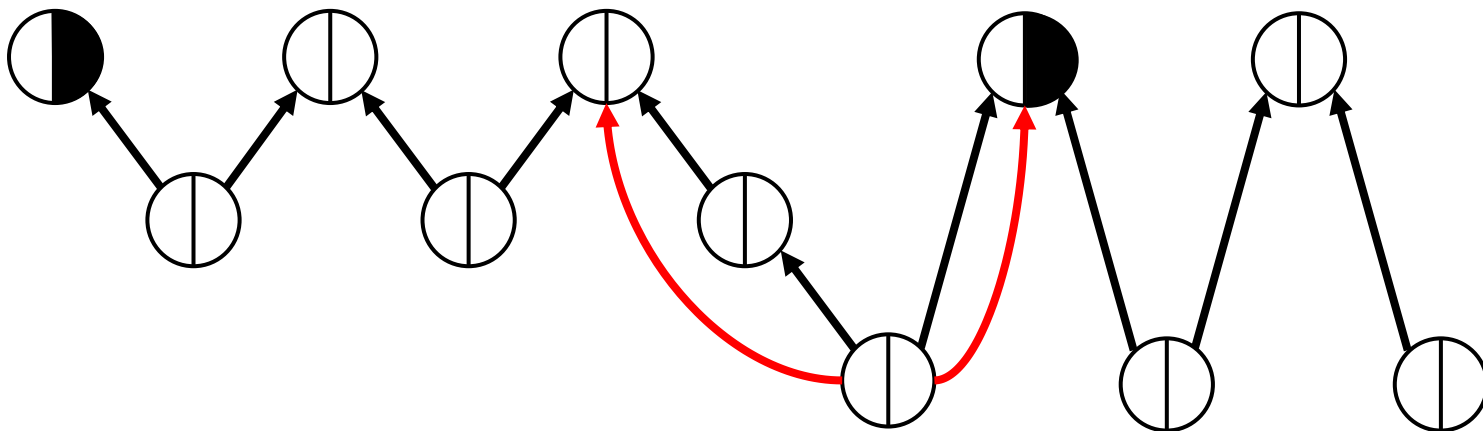

Time dilation example

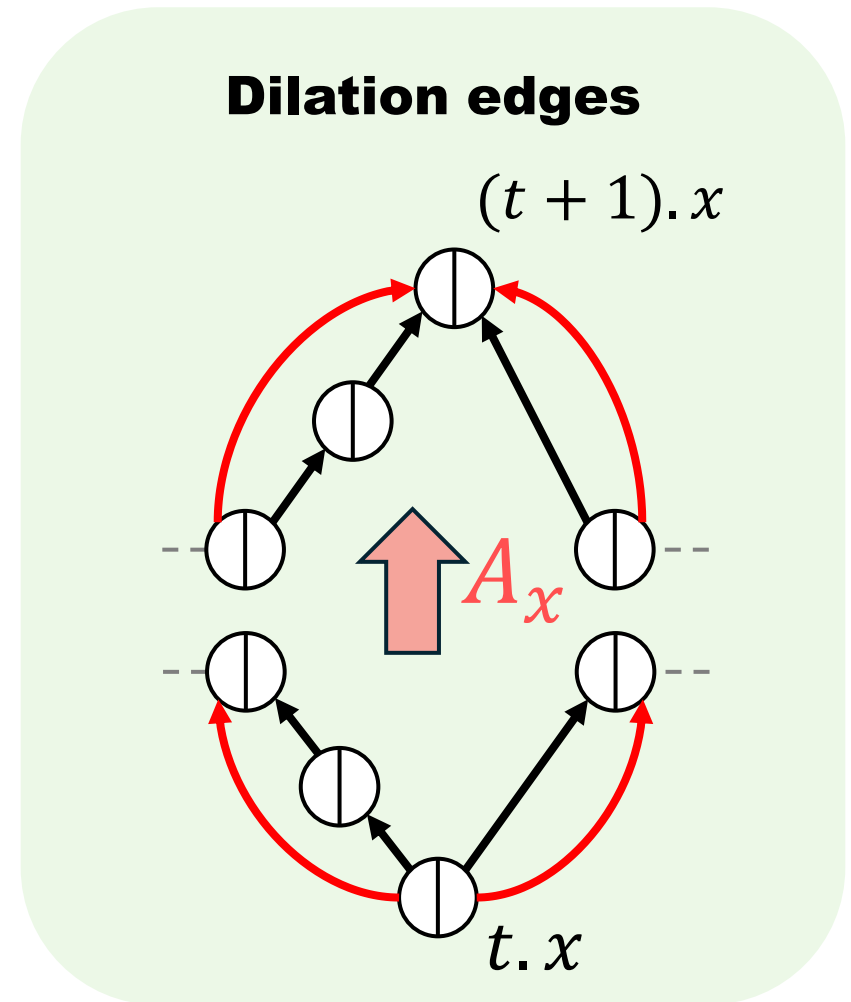
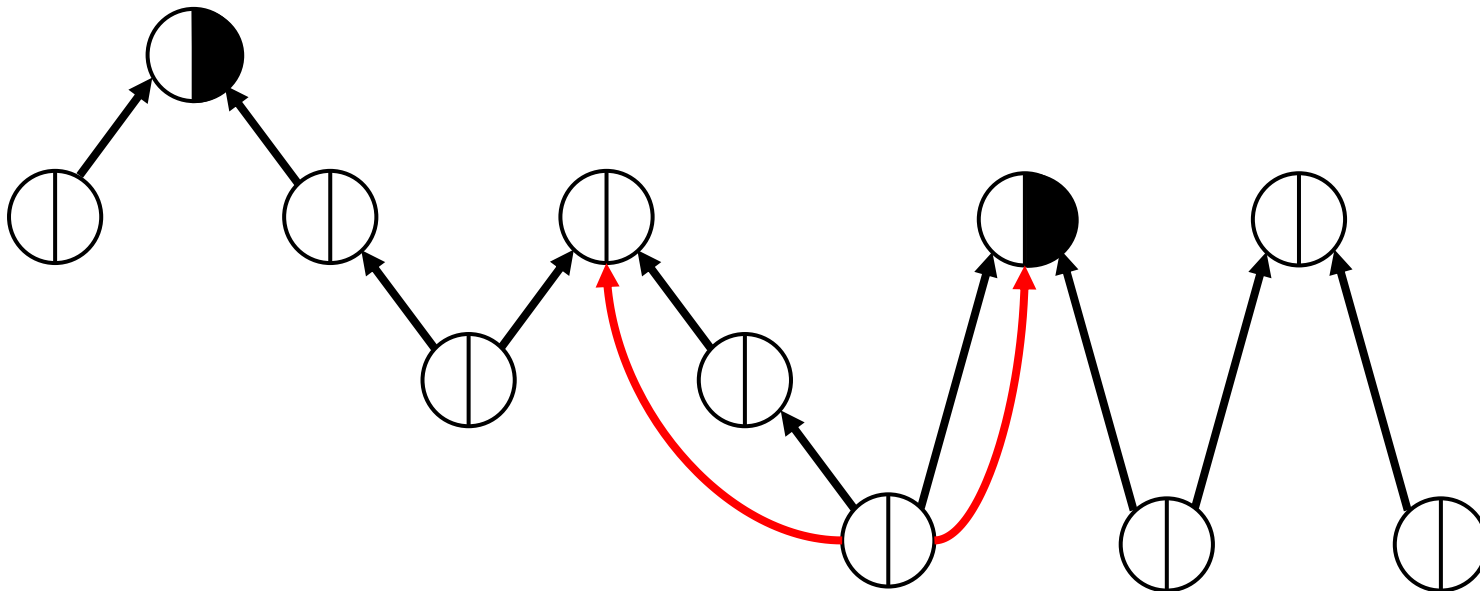

Time dilation example

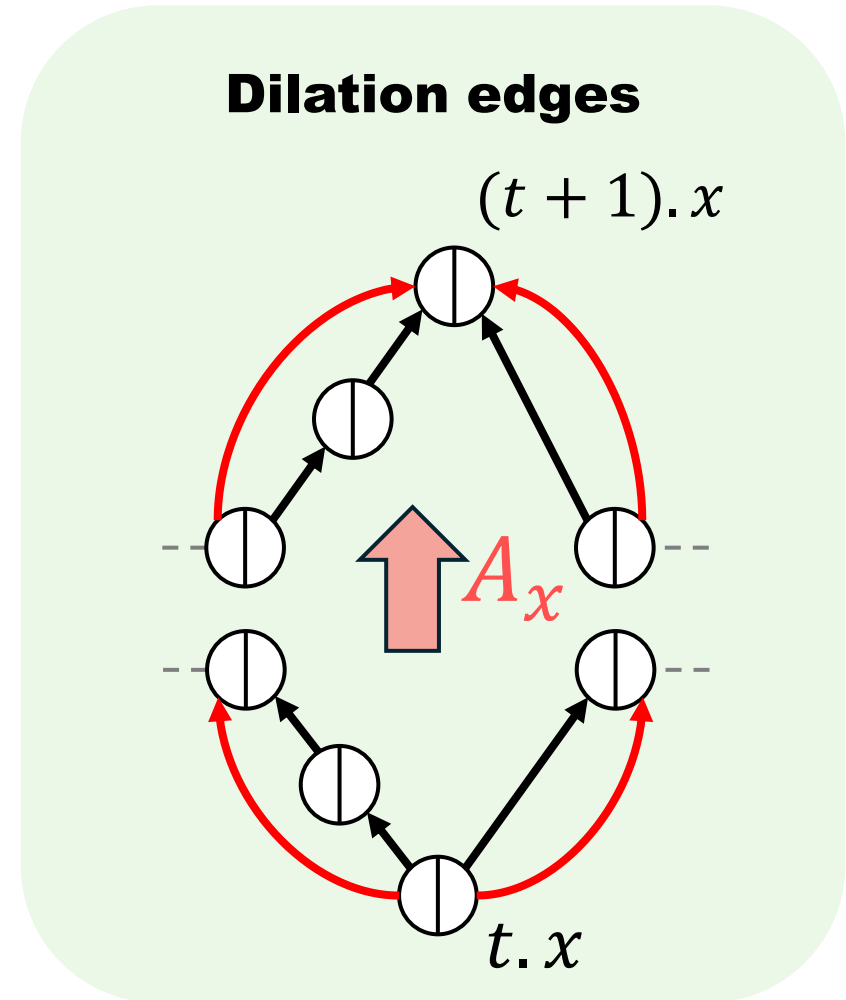
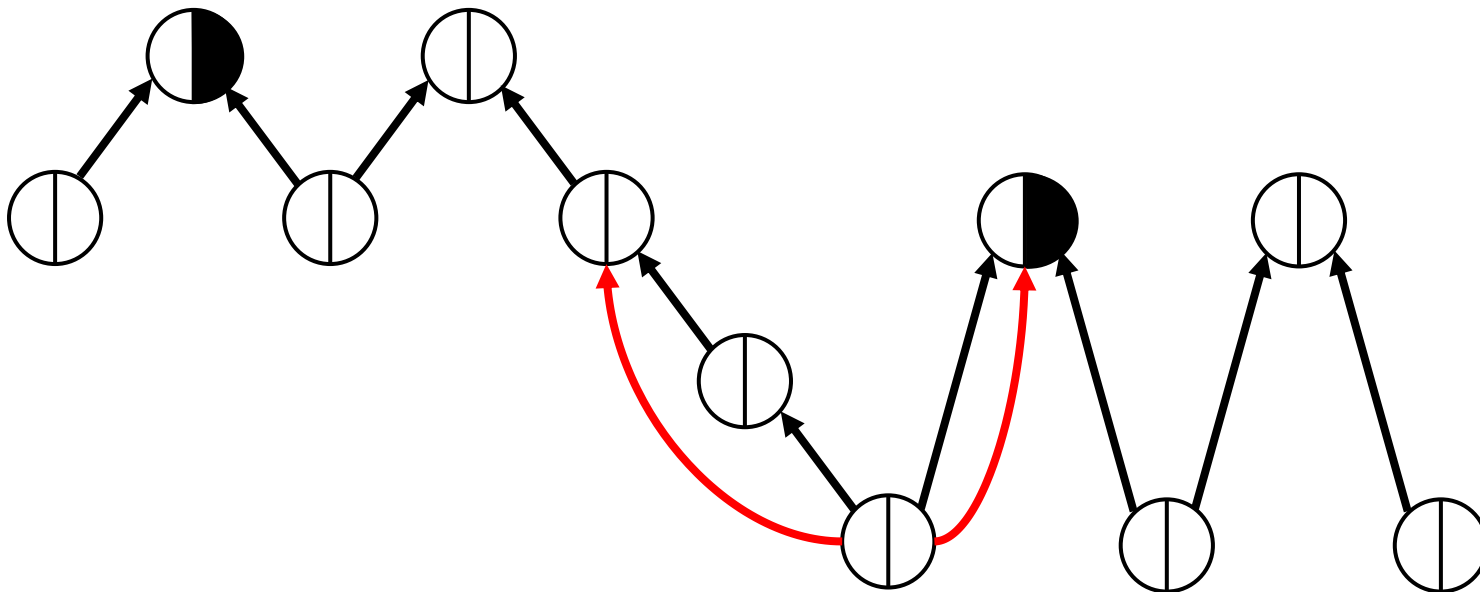

Time dilation example

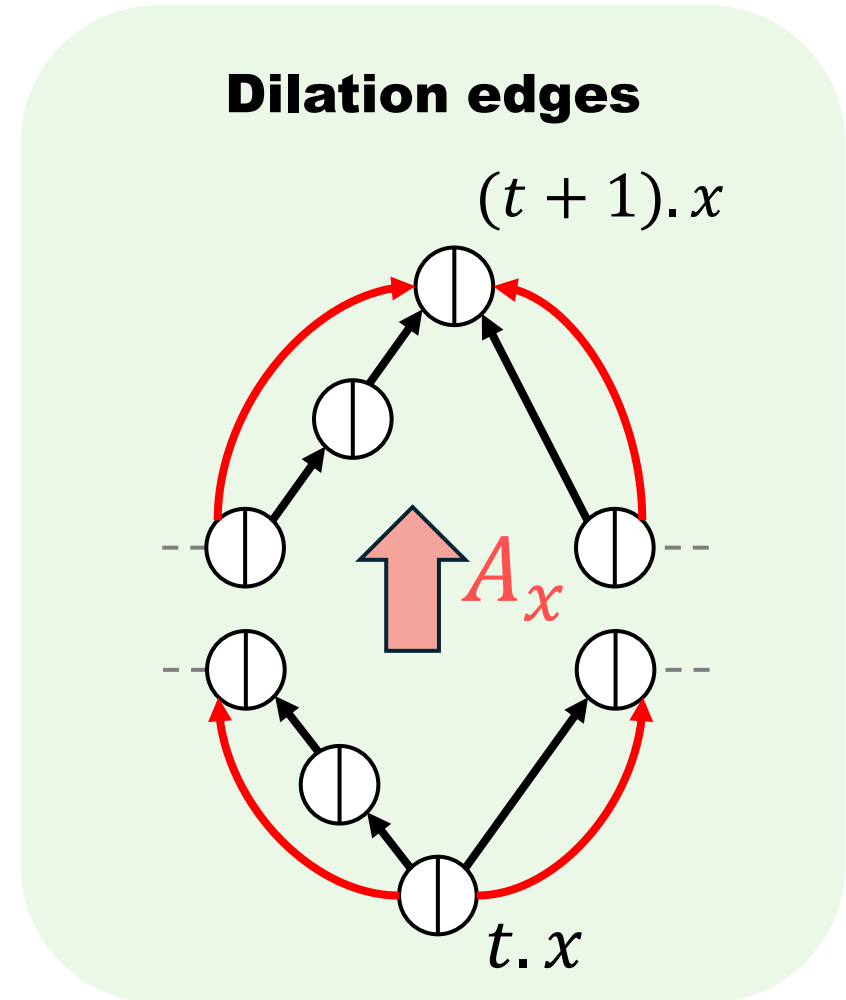
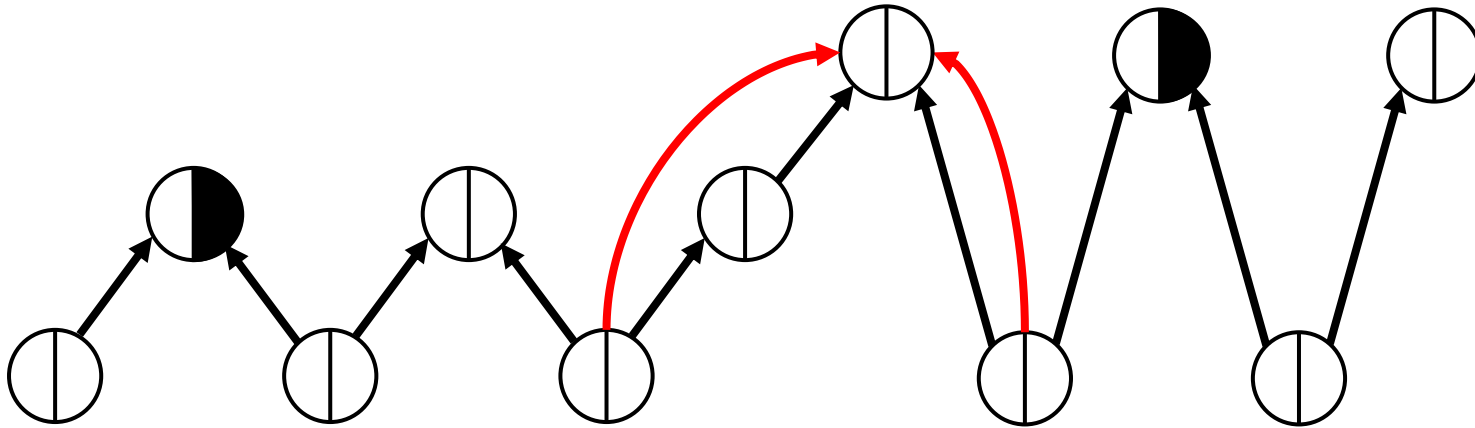

Time dilation example

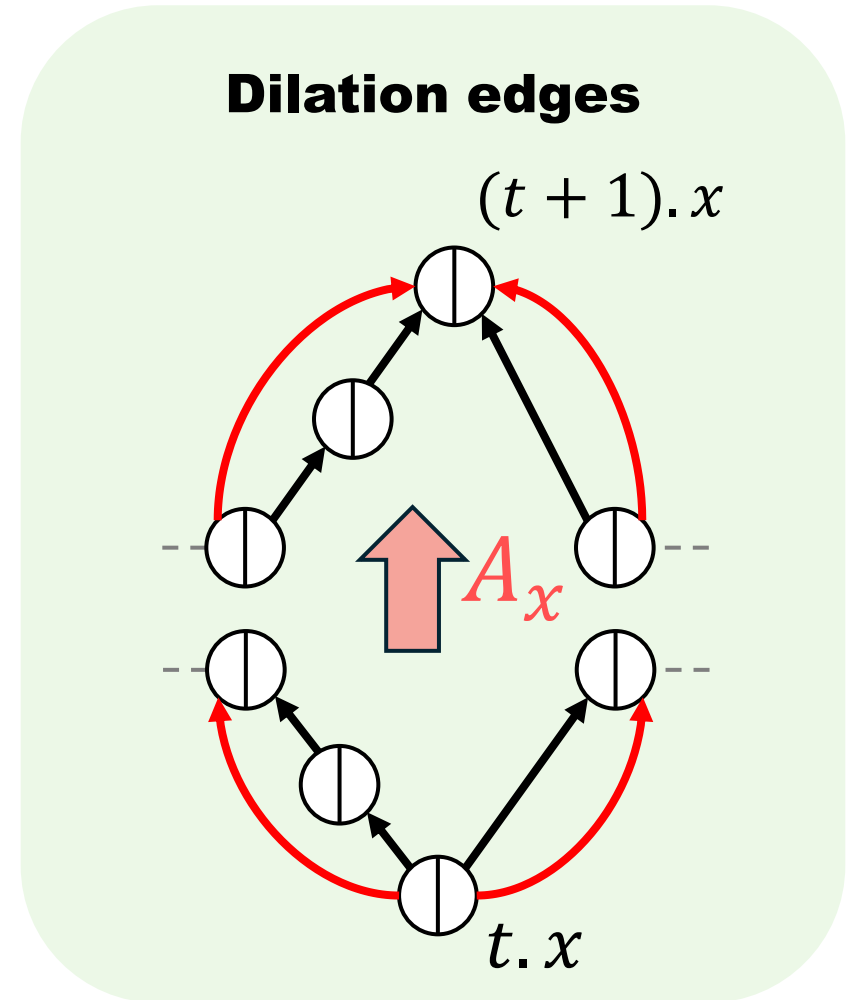
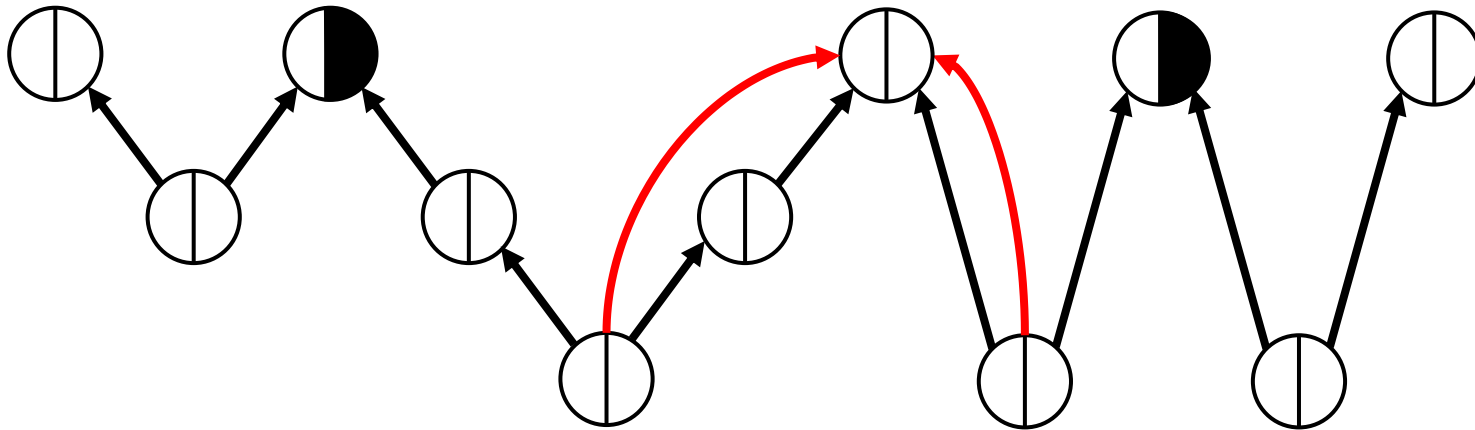

Time dilation example

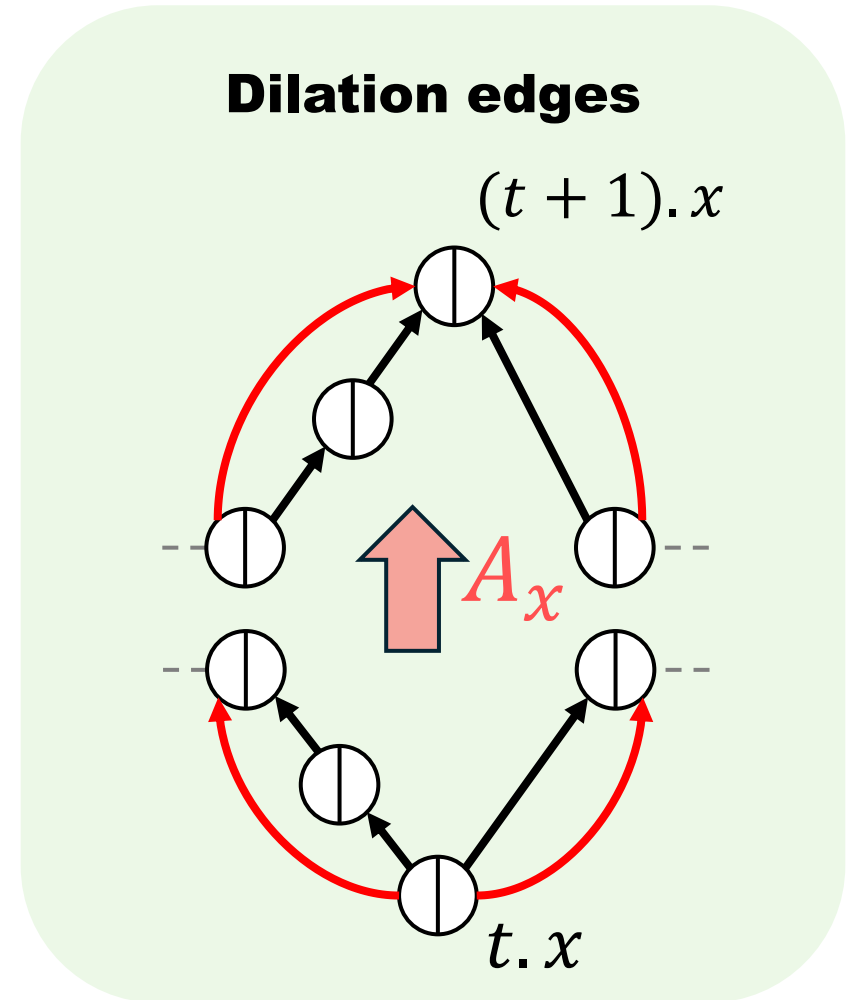
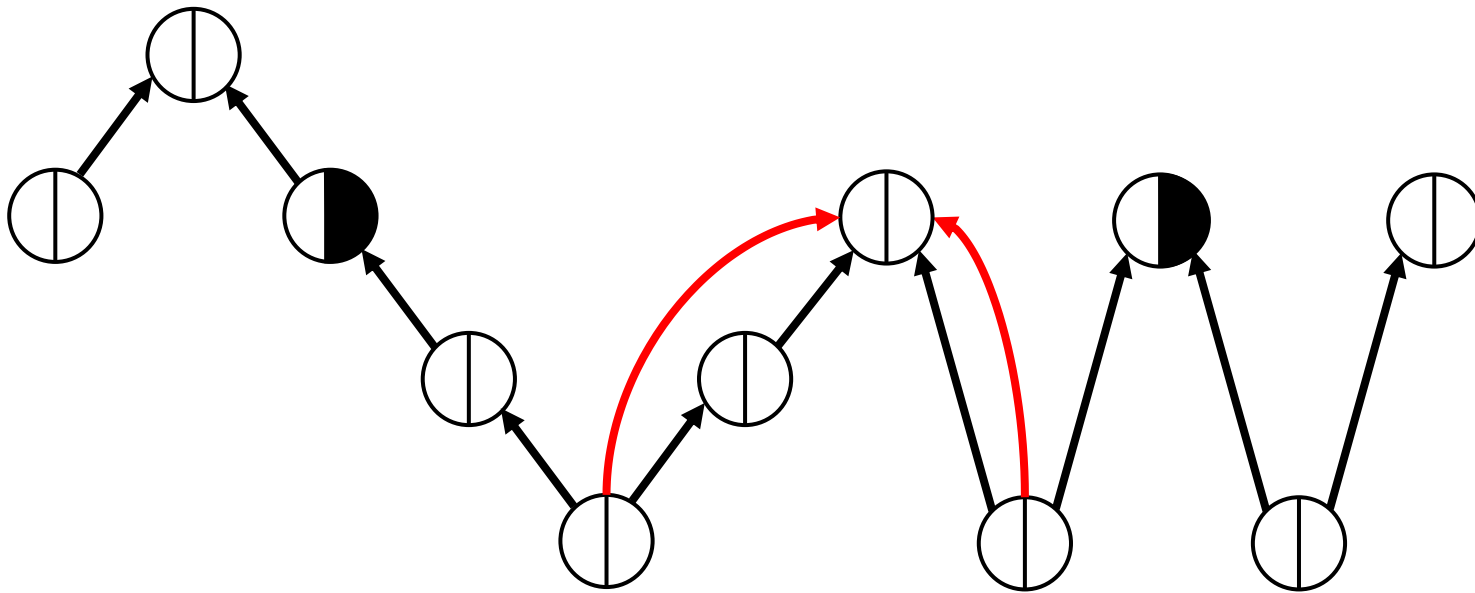

Time dilation example

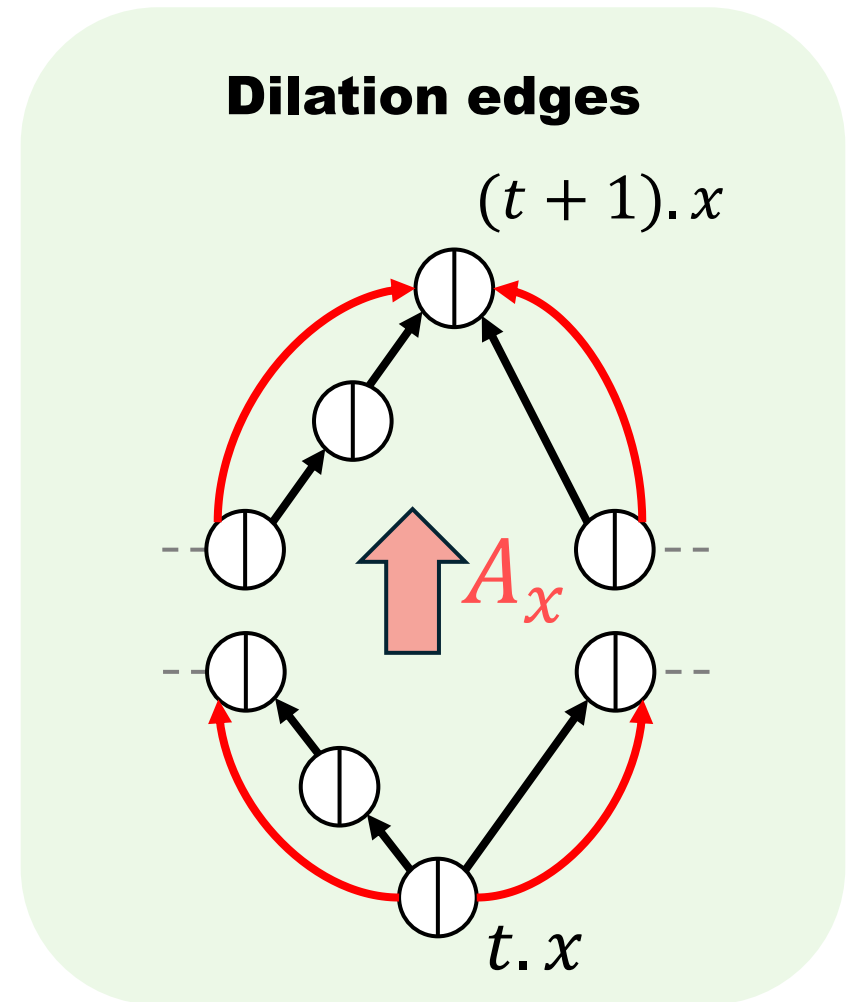
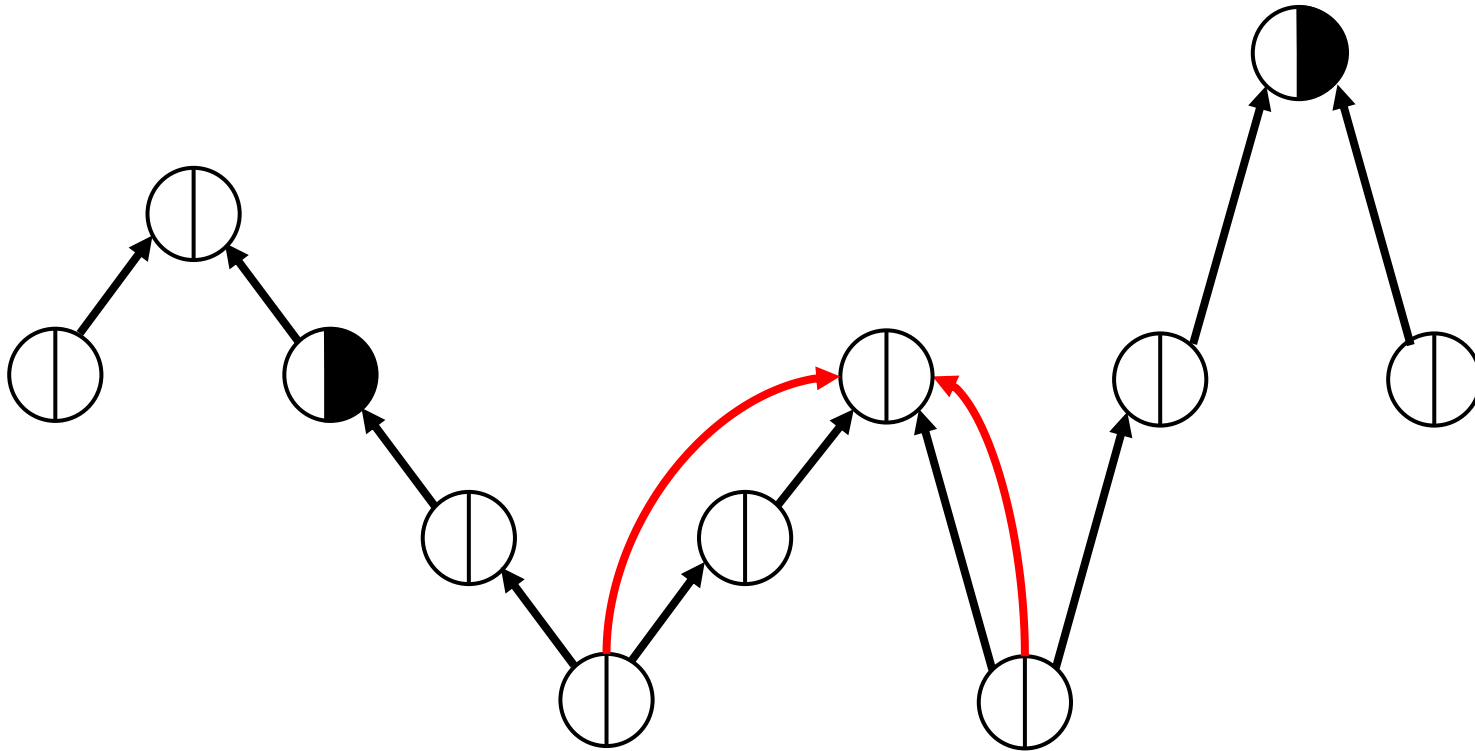

Time dilation example

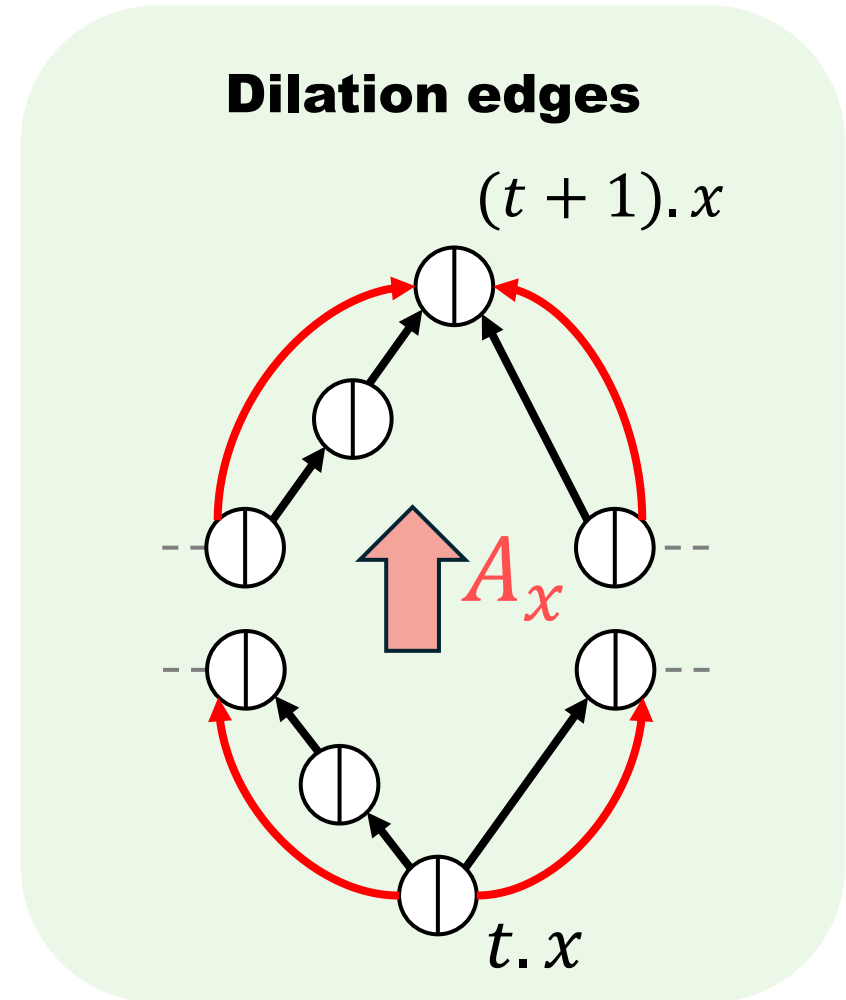
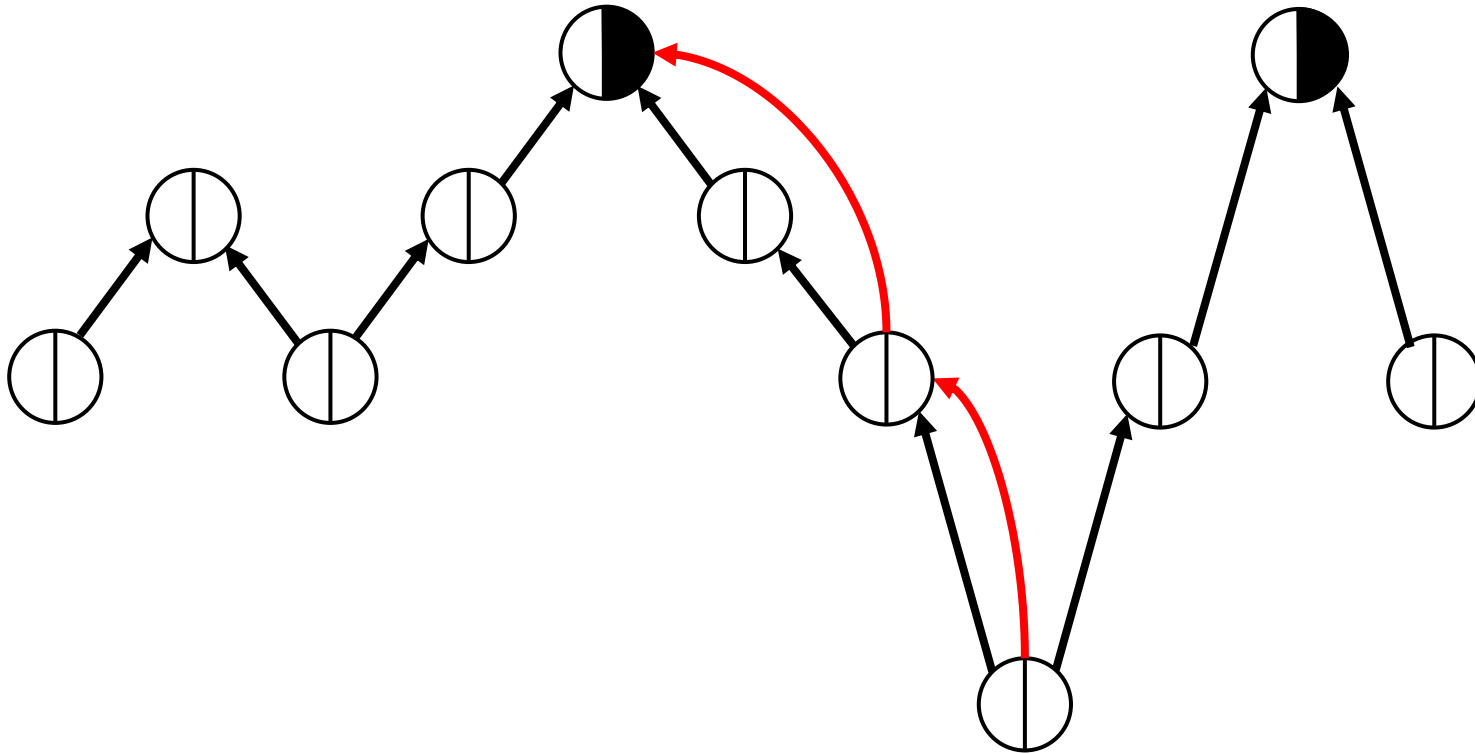

Time dilation example

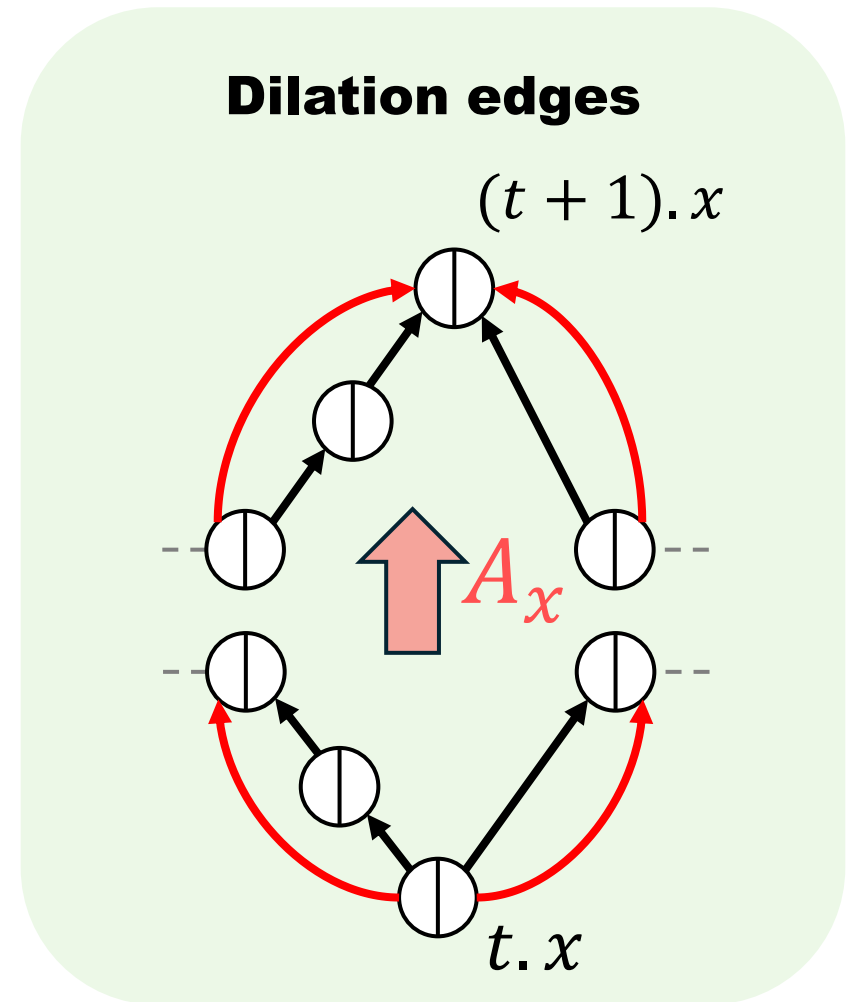
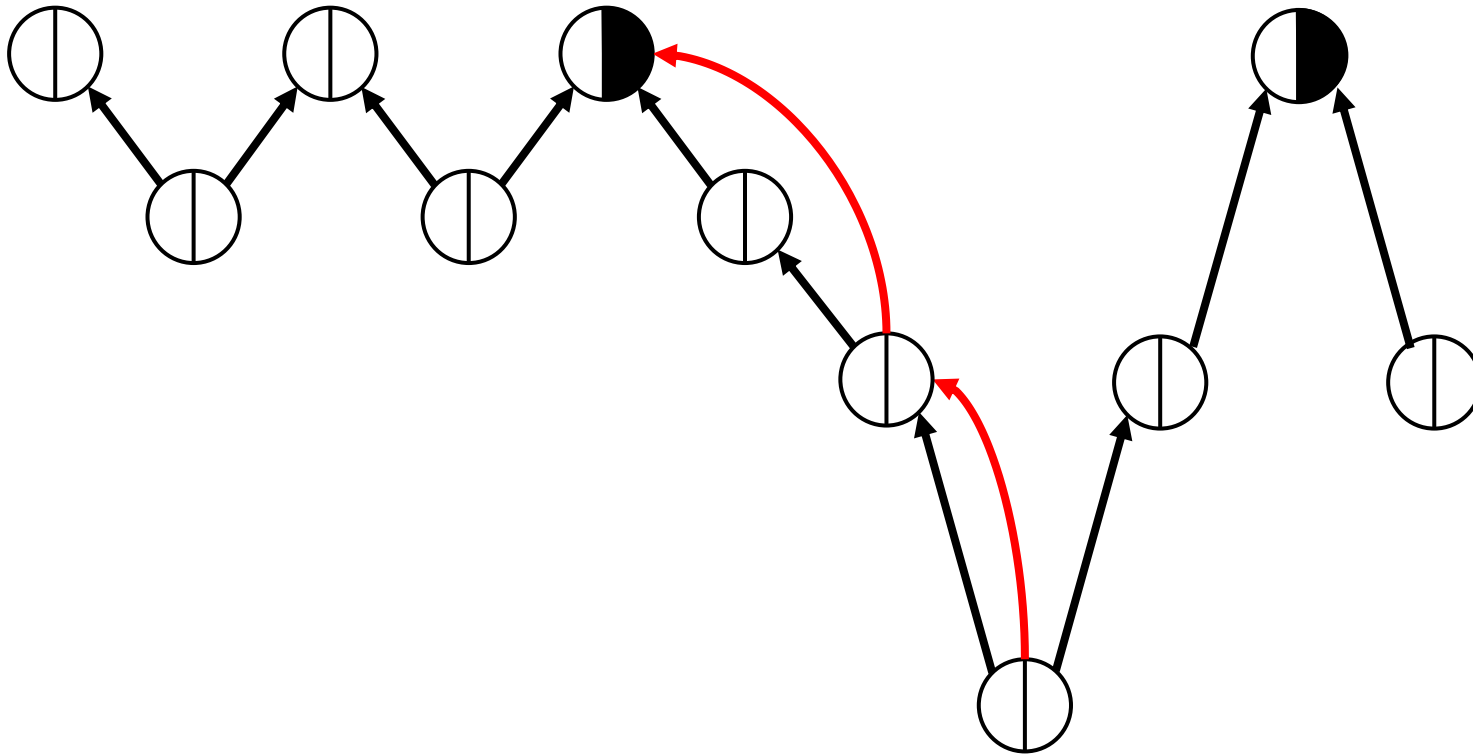

Time dilation example

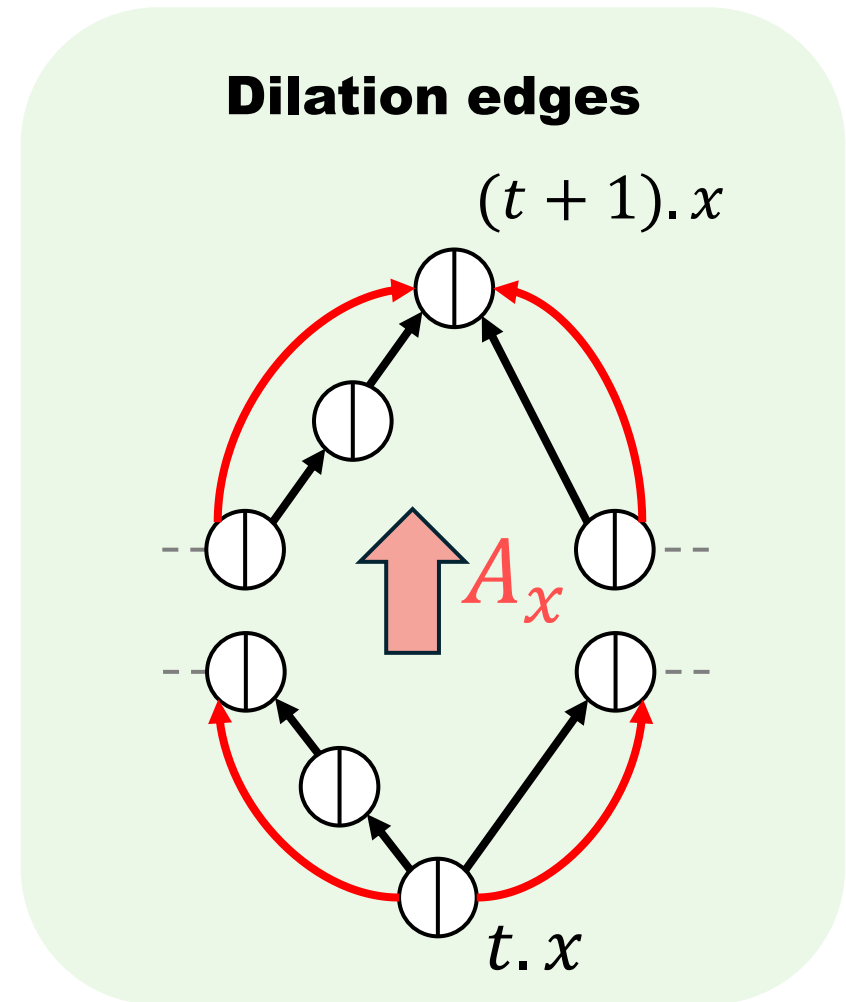
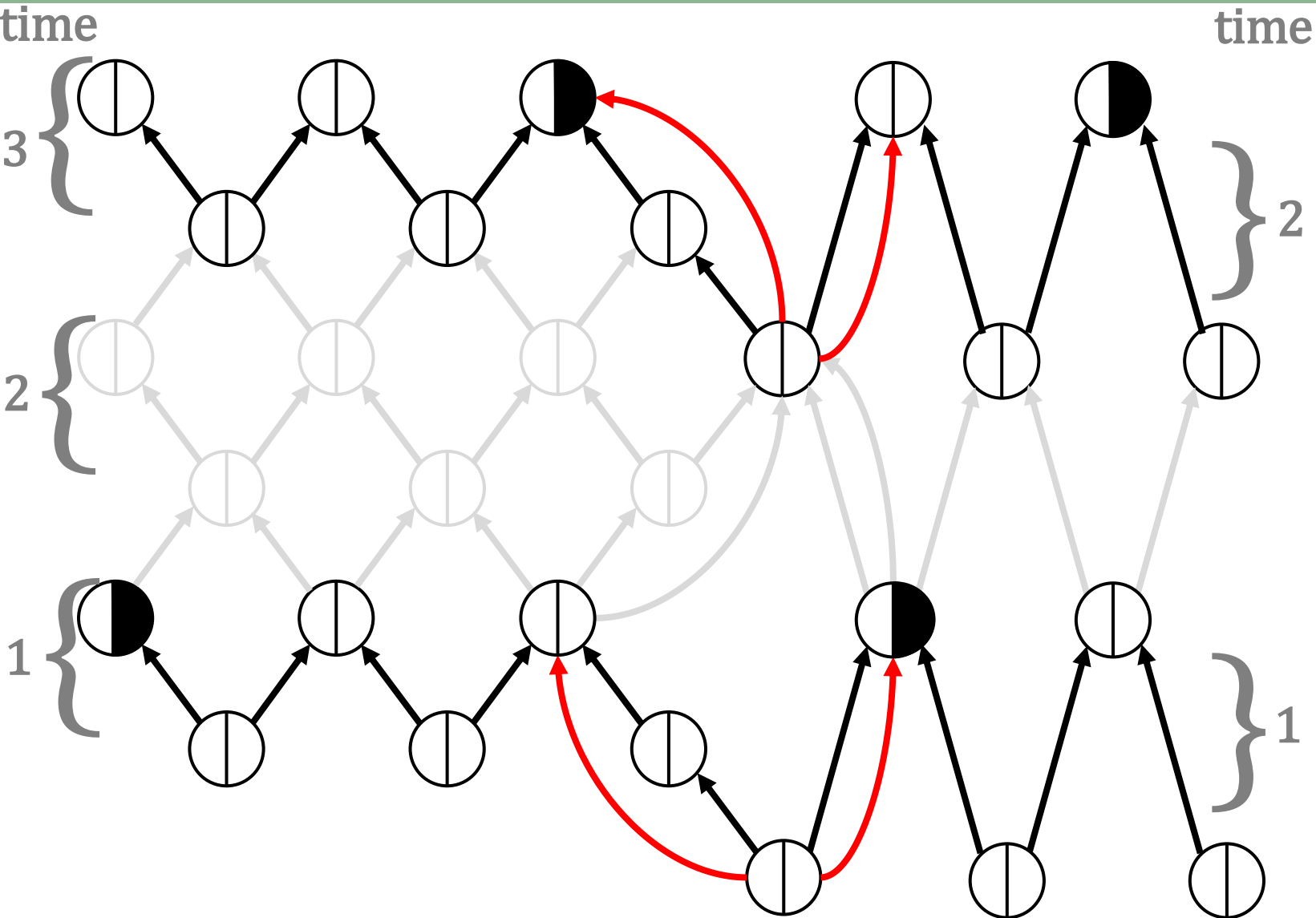

Summary

Using graph rewriting we **can simulate synchronous** dynamical system ...

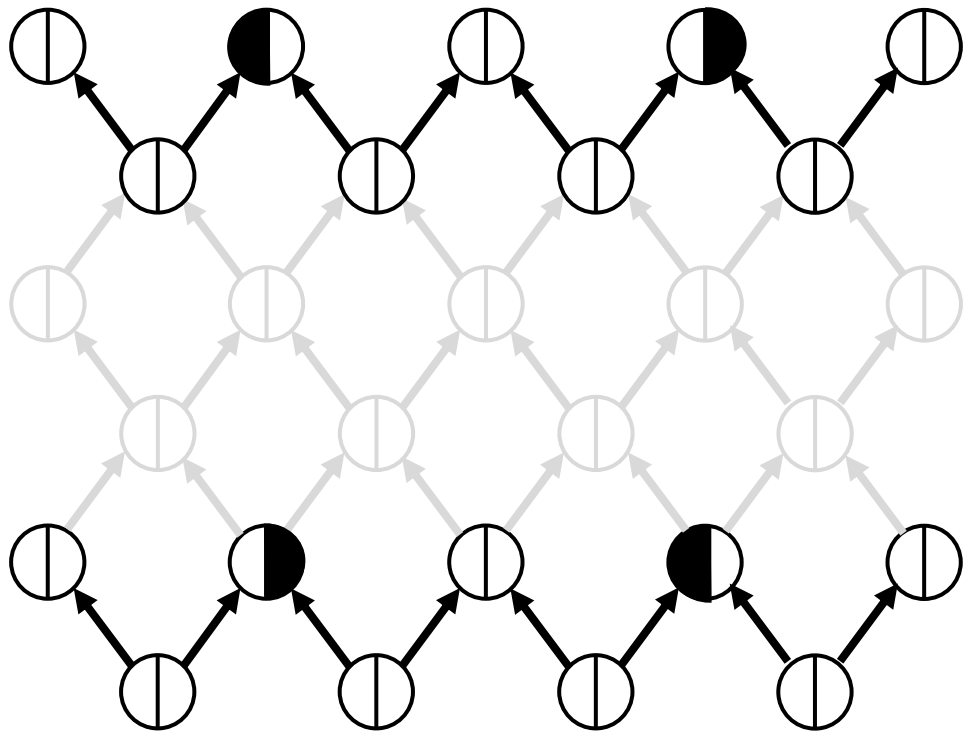

Summary

Using graph rewriting we **can simulate synchronous** dynamical system ...

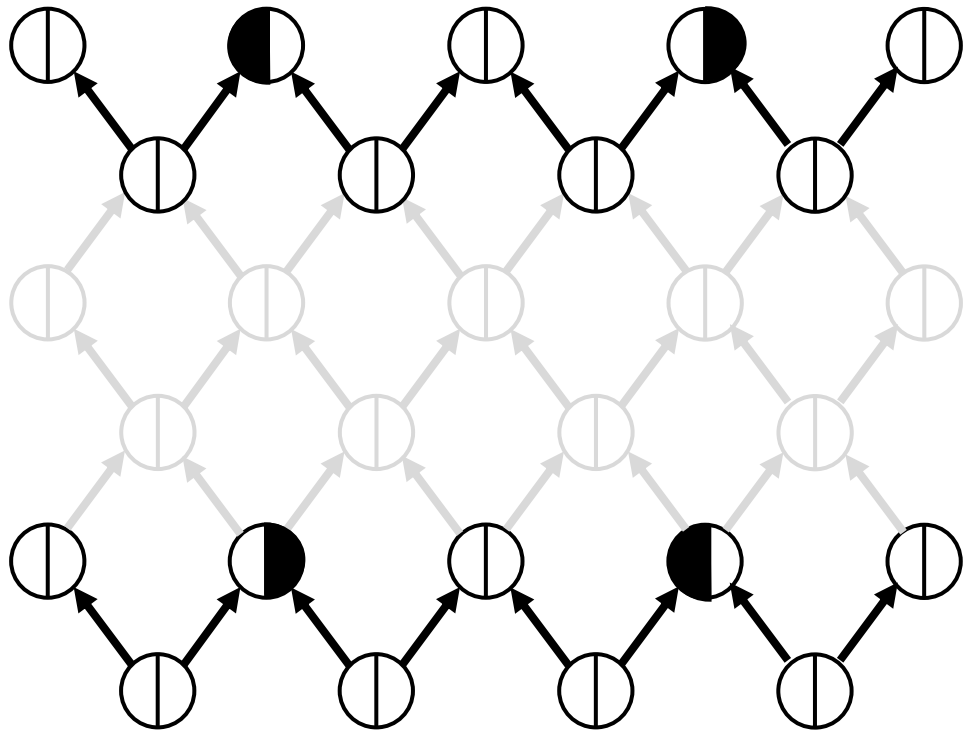

... but also represent some **intrinsically asynchronous** evolution.

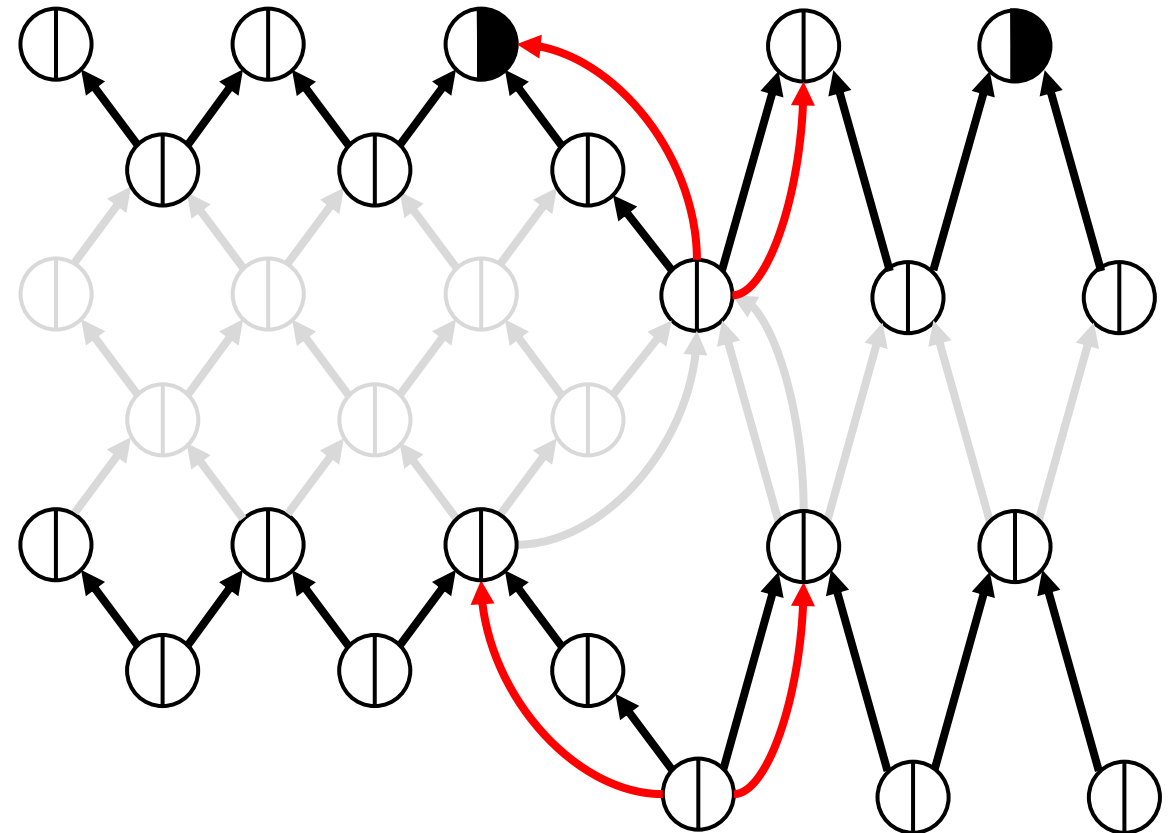

General framework

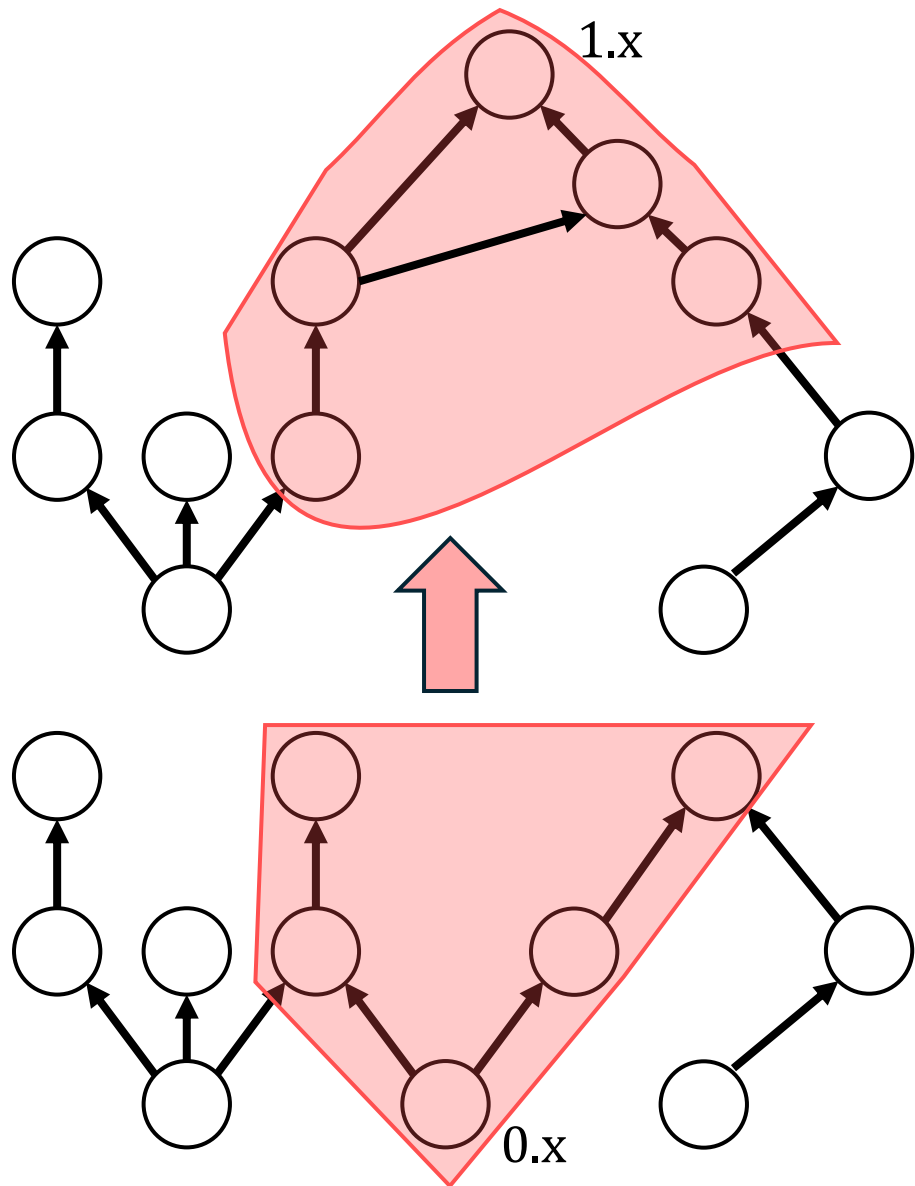

General framework

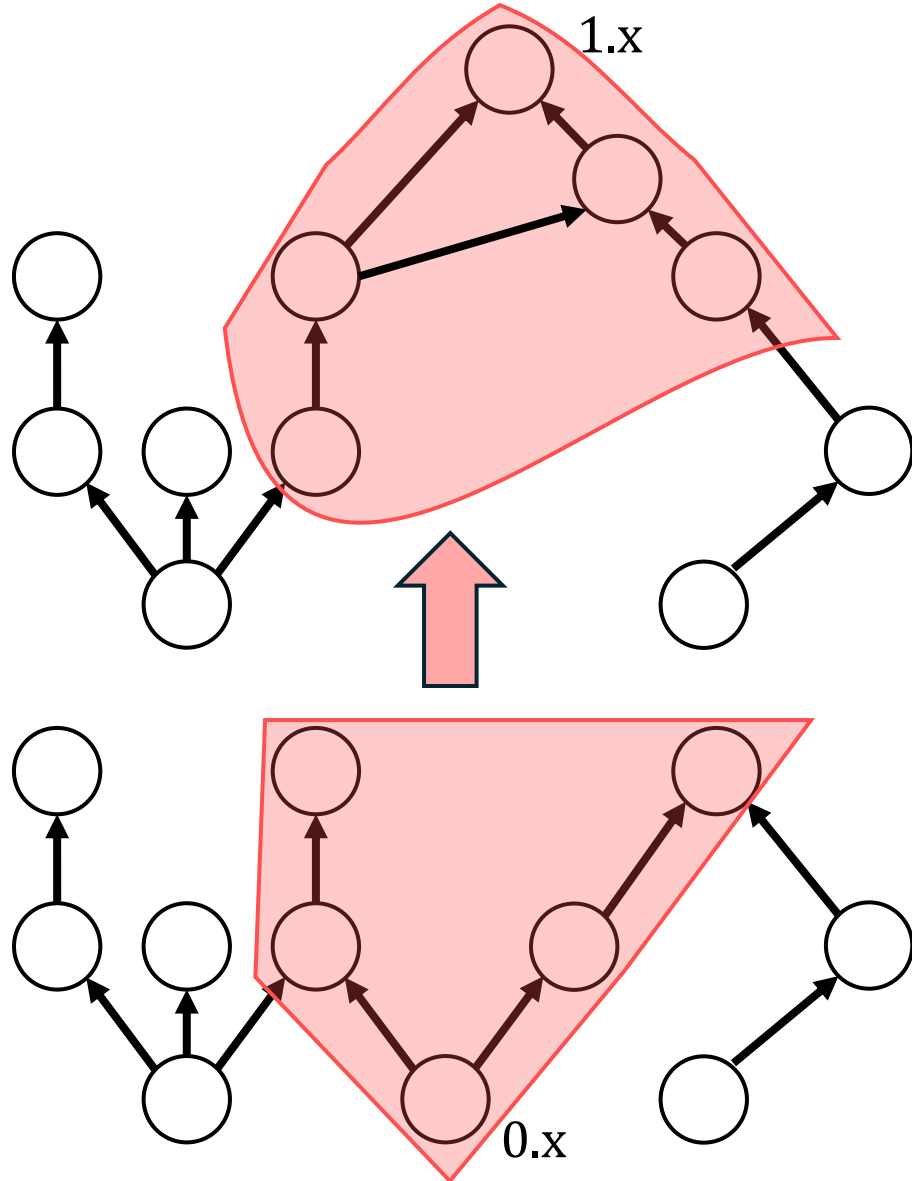

Which rewriting rules ensure that the dynamic do not depend on the rewriting strategy?

- **Confluence**



General framework

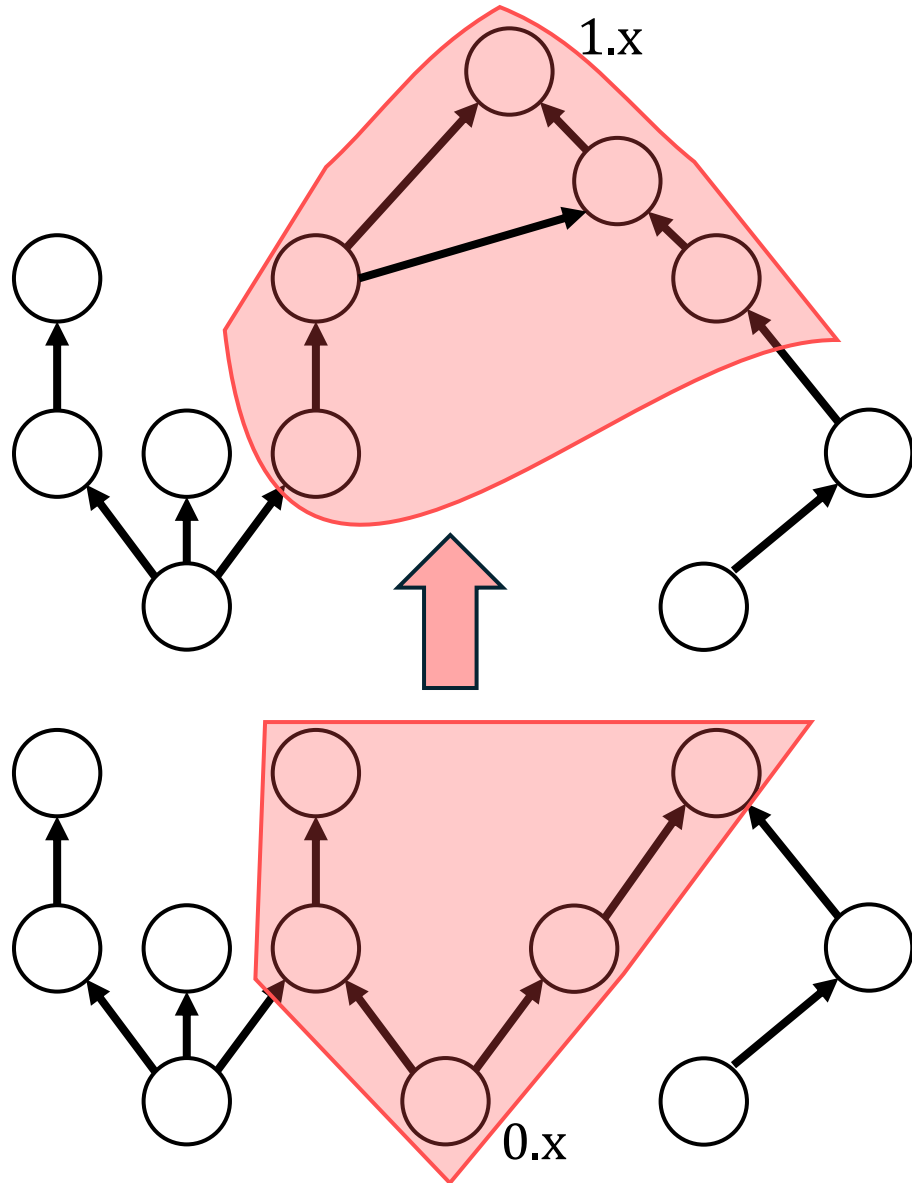

Which rewriting rules ensure that the dynamic do not depend on the rewriting strategy?

~~• **Confluence**~~

• **Space-time determinism**

A first attempt at defining determinism

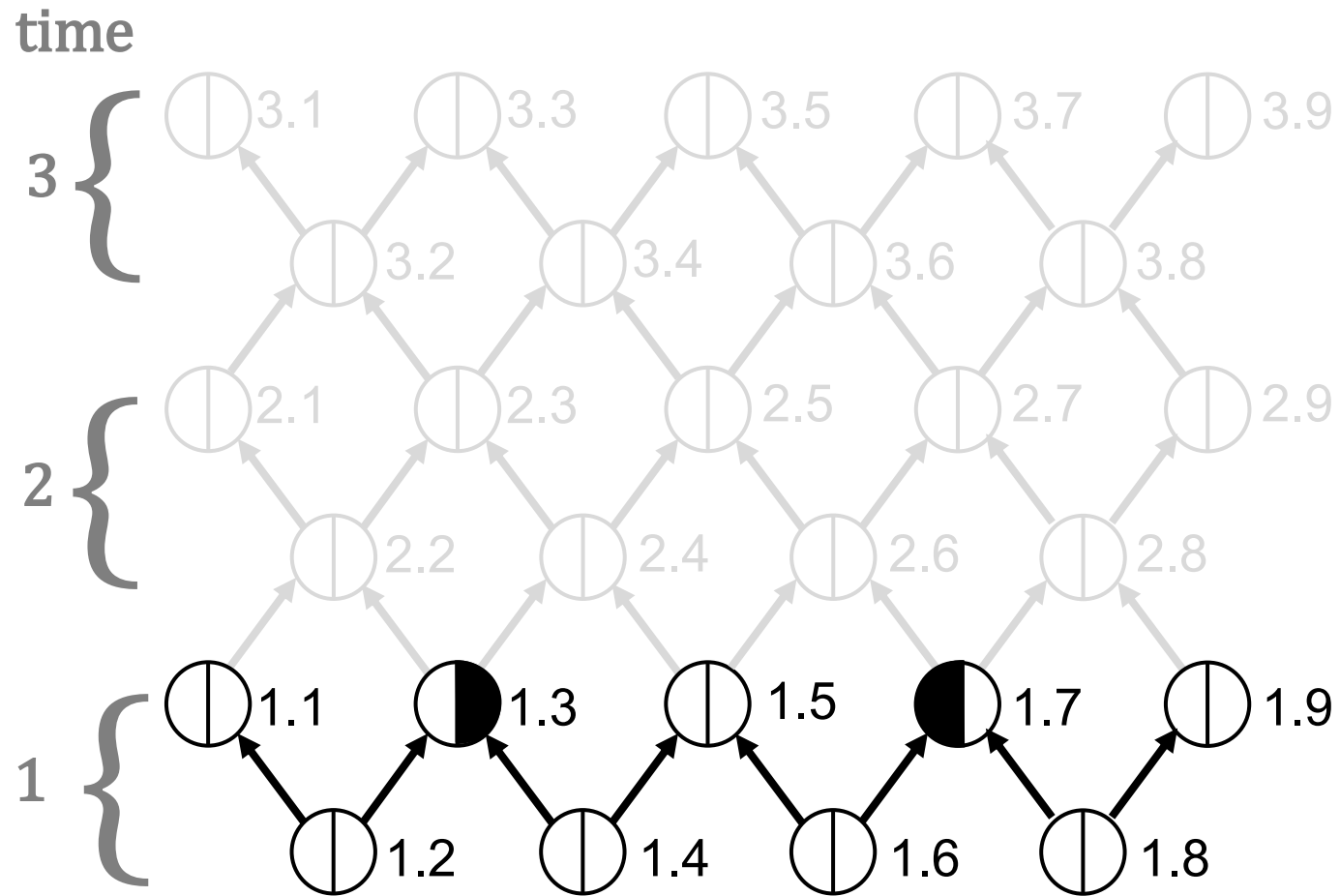

A first attempt at defining determinism

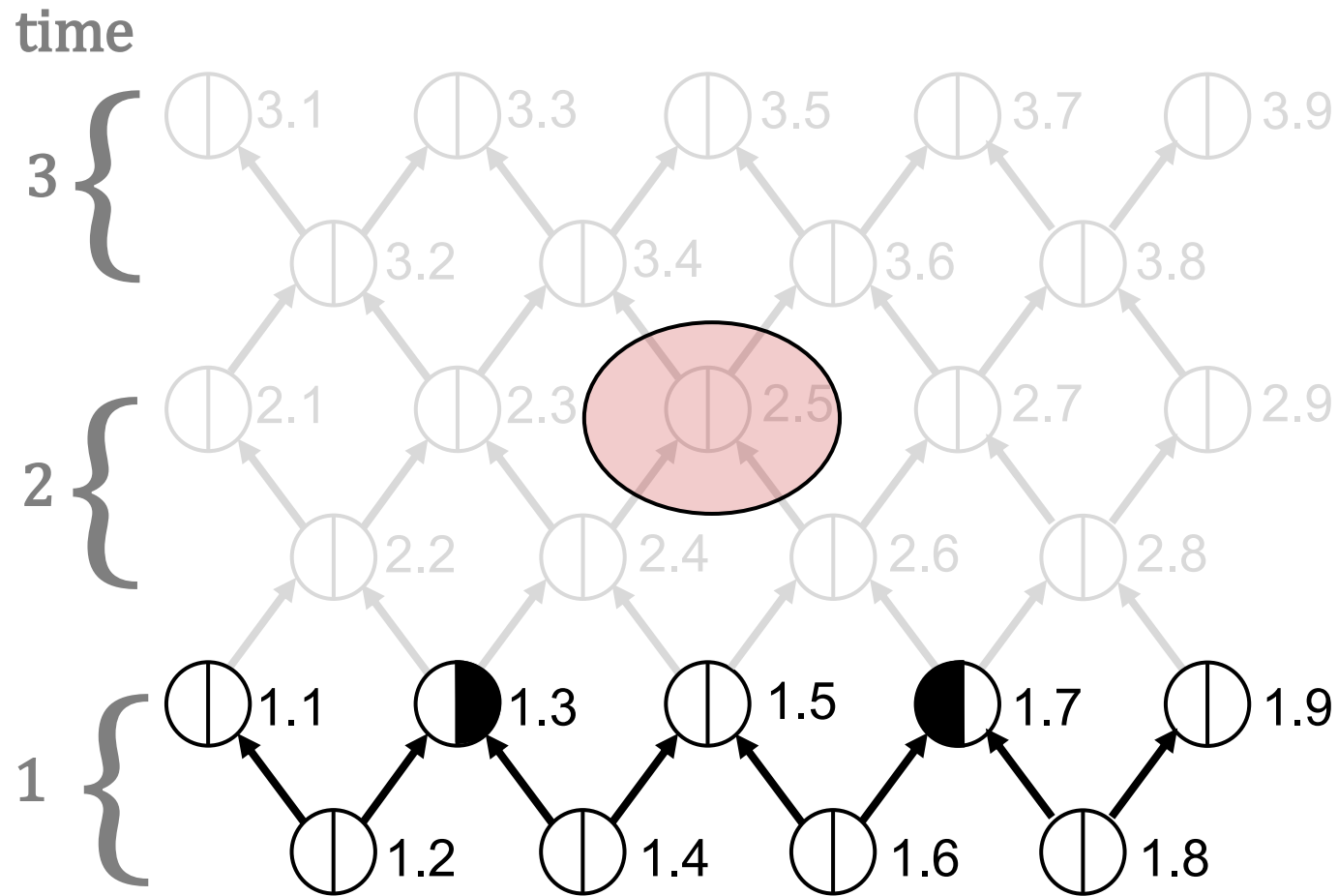

Naive determinism

The **state** of 2.5 is the **same in all cuts** passing by this node.

A first attempt at defining determinism

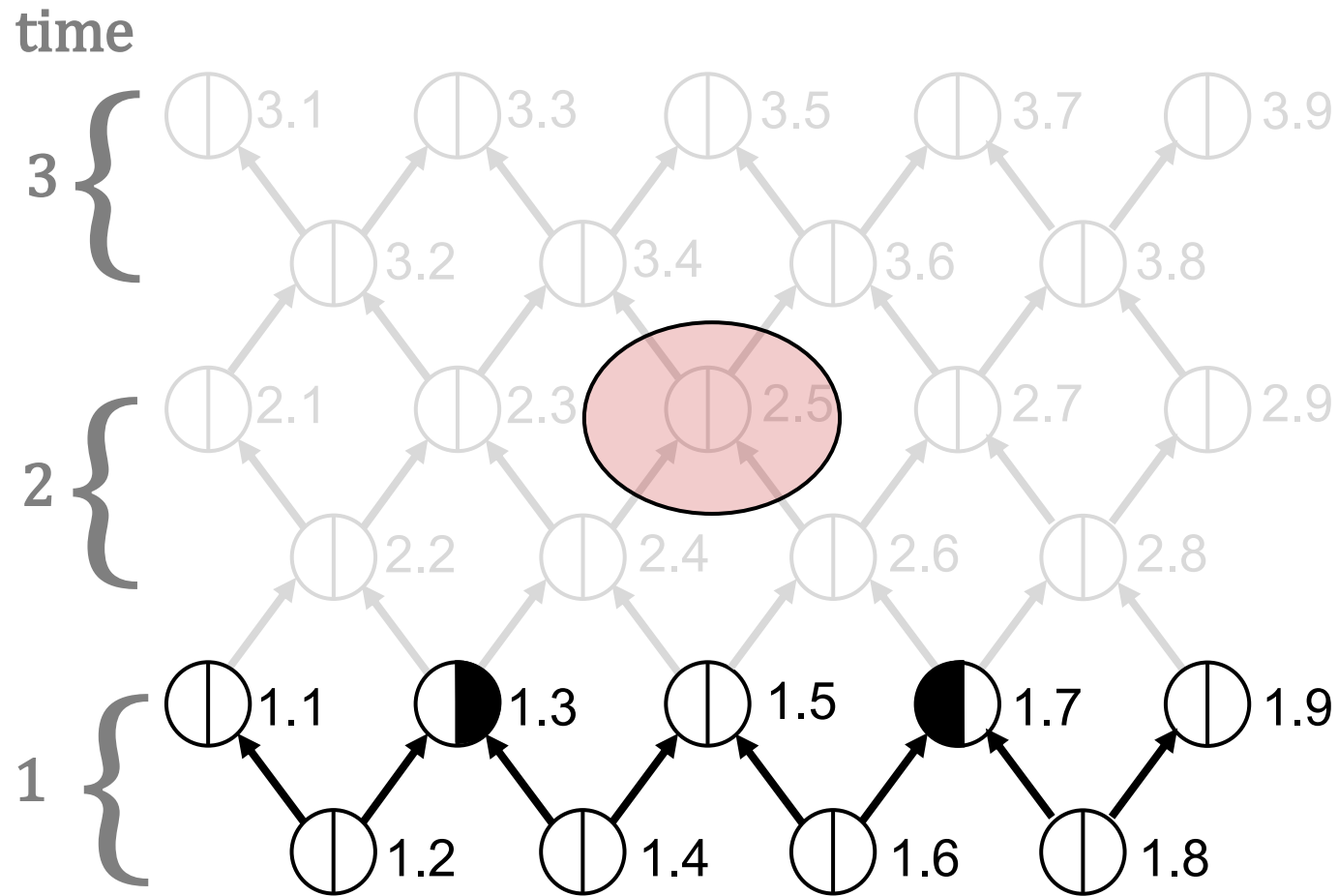

~~Naive determinism~~

~~The **state** of 2.5 is the **same** in all cuts passing by this node.~~

It should depend
on the local
shape of the cut !

States depend on the cut

G

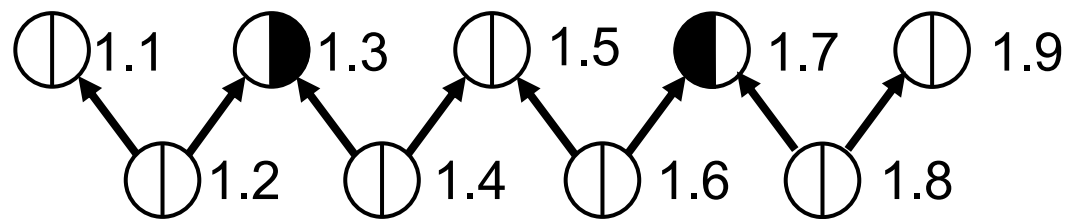

States depend on the cut

A_4G

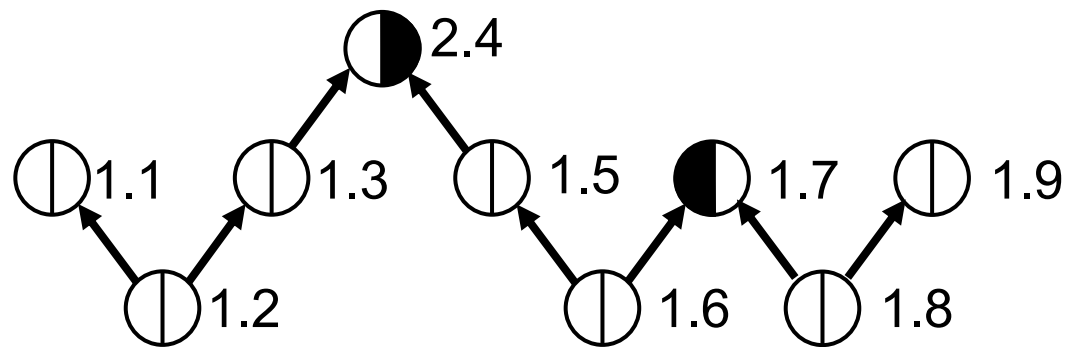

States depend on the cut

$A_6 A_4 G$

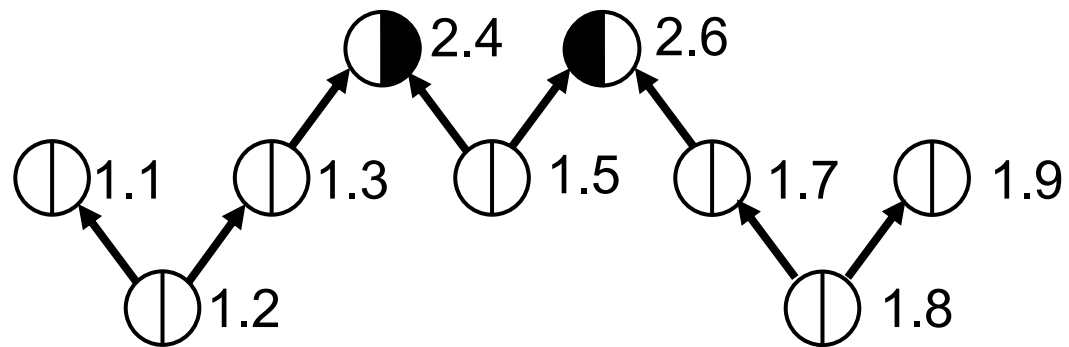

States depend on the cut

$A_5 A_6 A_4 G$

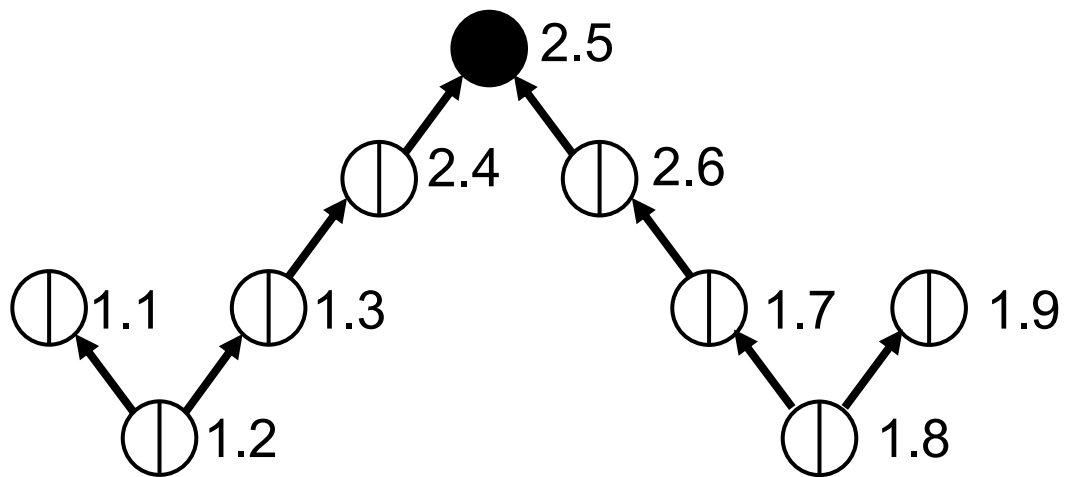

States depend on the cut

$A_5 A_6 A_4 G$

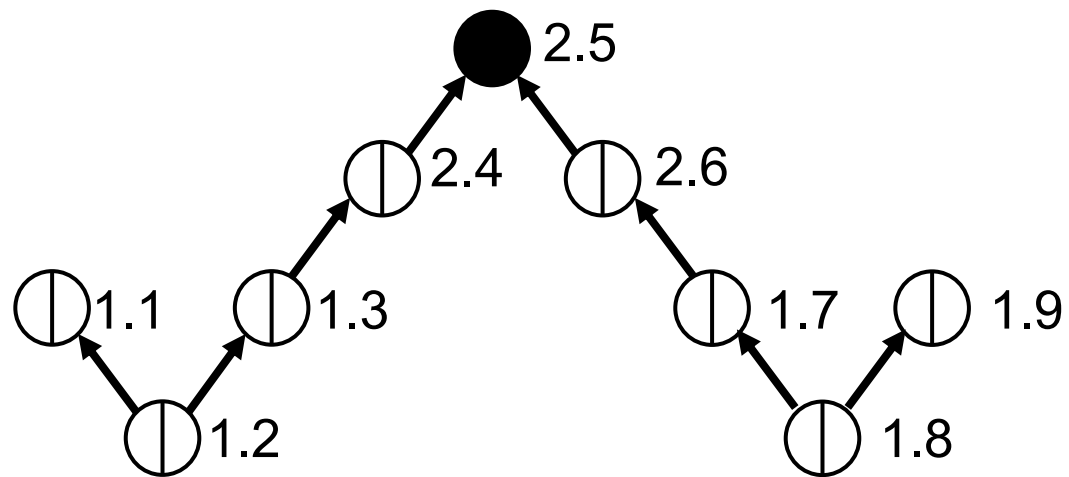

G

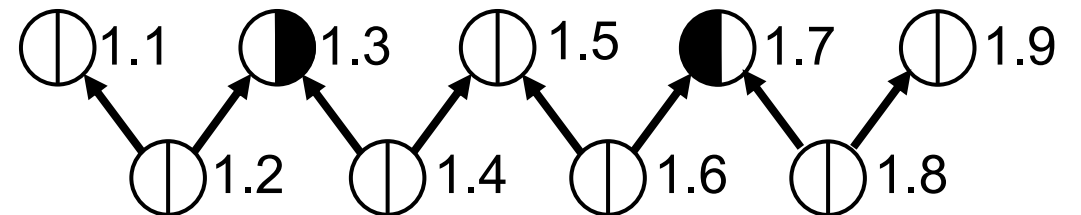

States depend on the cut

$A_5 A_6 A_4 G$

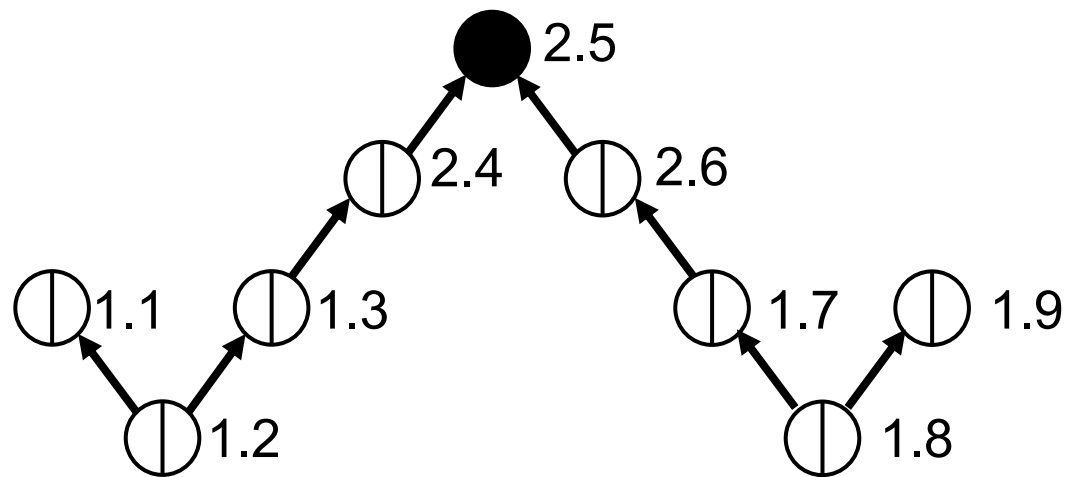

$A_5 A_6 A_4 G$

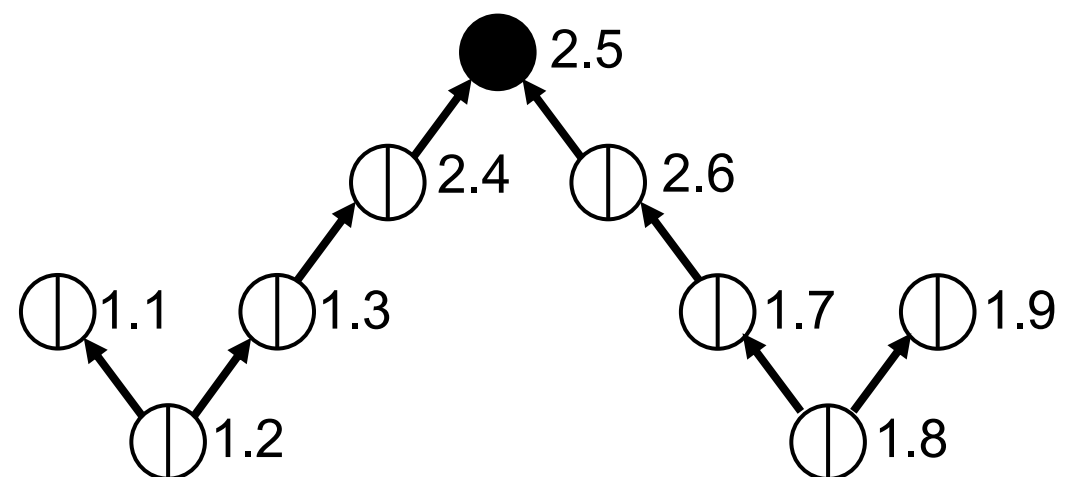

States depend on the cut

$A_5 A_6 A_4 G$

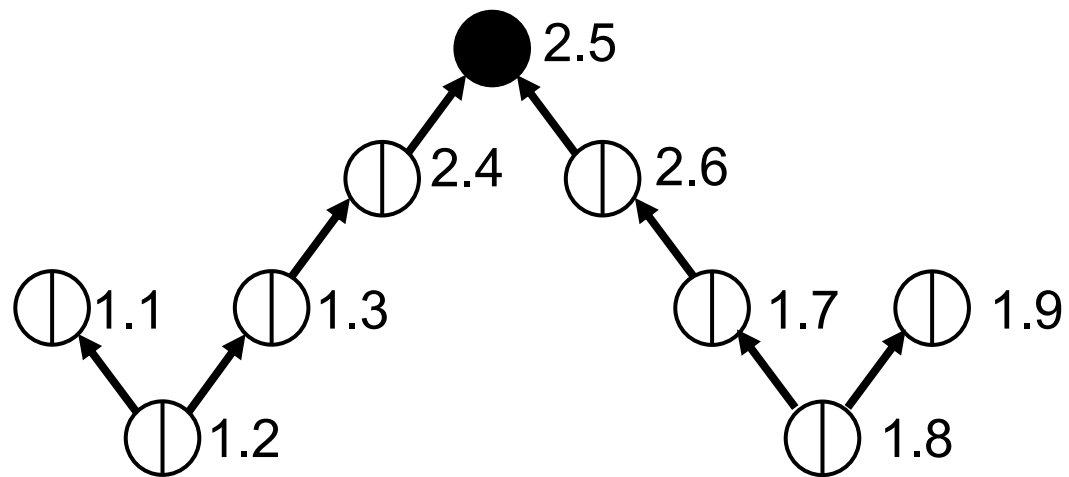

$A_8 A_5 A_6 A_4 G$

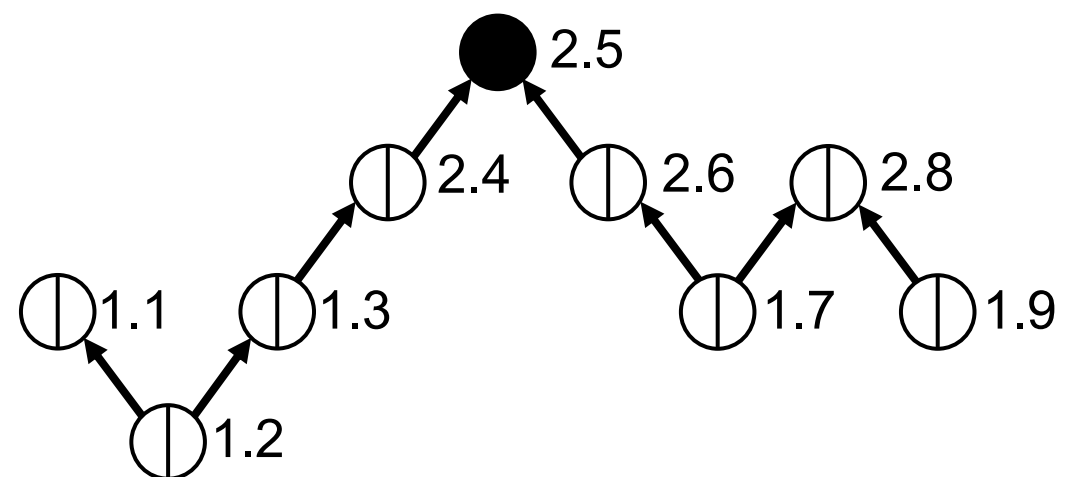

States depend on the cut

$A_5 A_6 A_4 G$

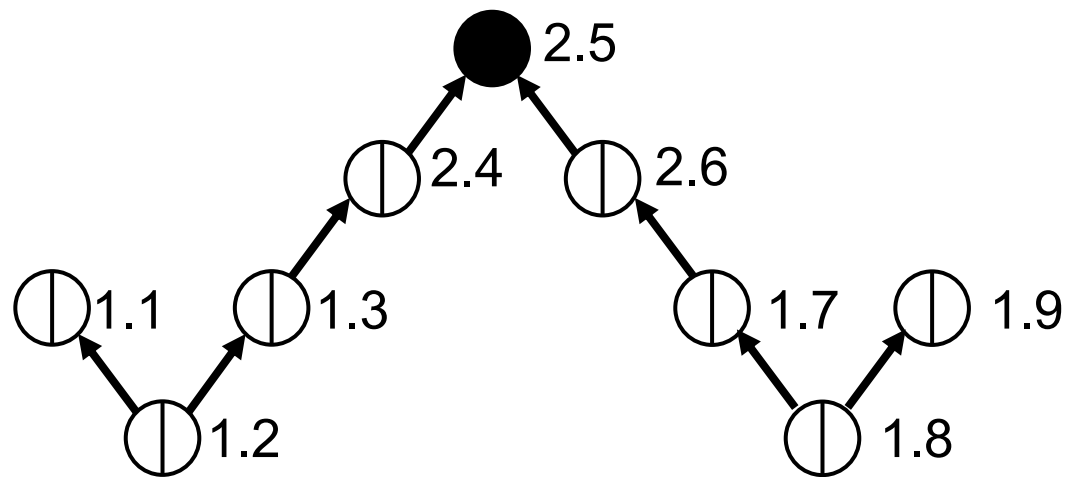

$A_8 A_5 A_6 A_4 G$

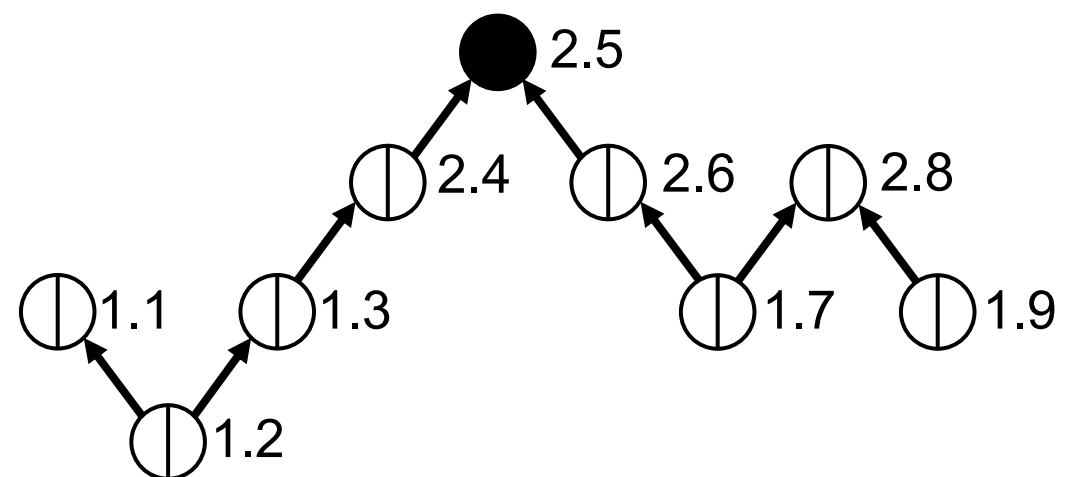

States depend on the cut

$A_5 A_6 A_4 G$

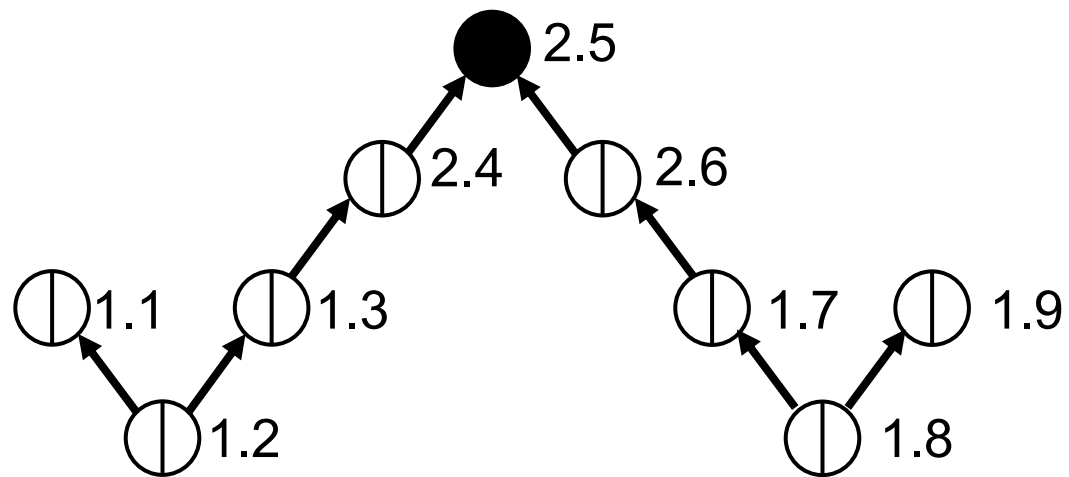

$A_9 A_7 A_8 A_5 A_6 A_4 G$

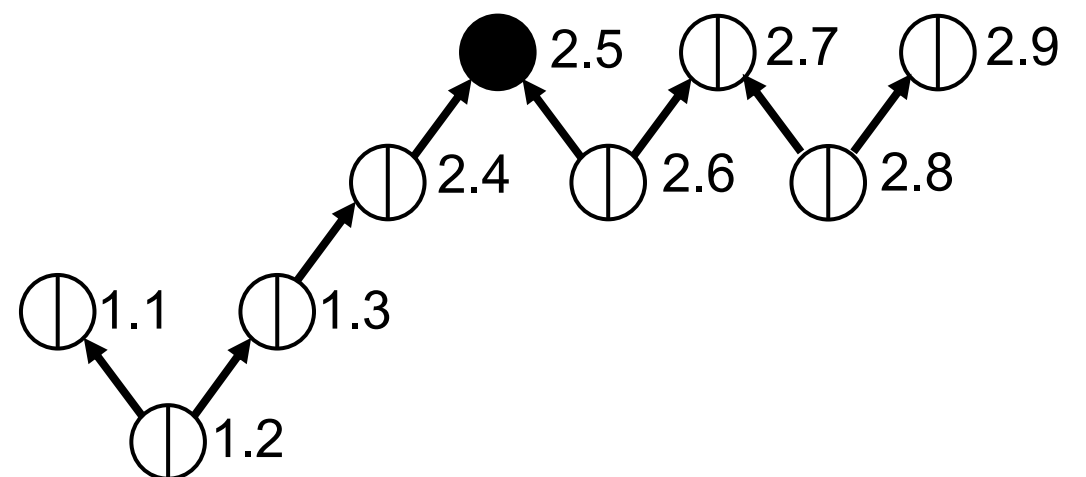

States depend on the cut

$A_5 A_6 A_4 G$

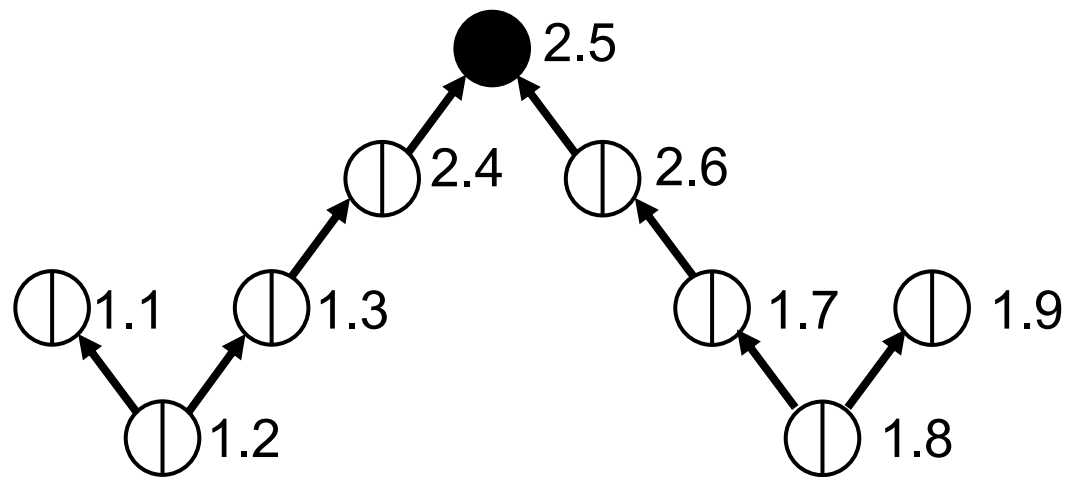

$A_6 A_9 A_8 A_5 A_4 G$

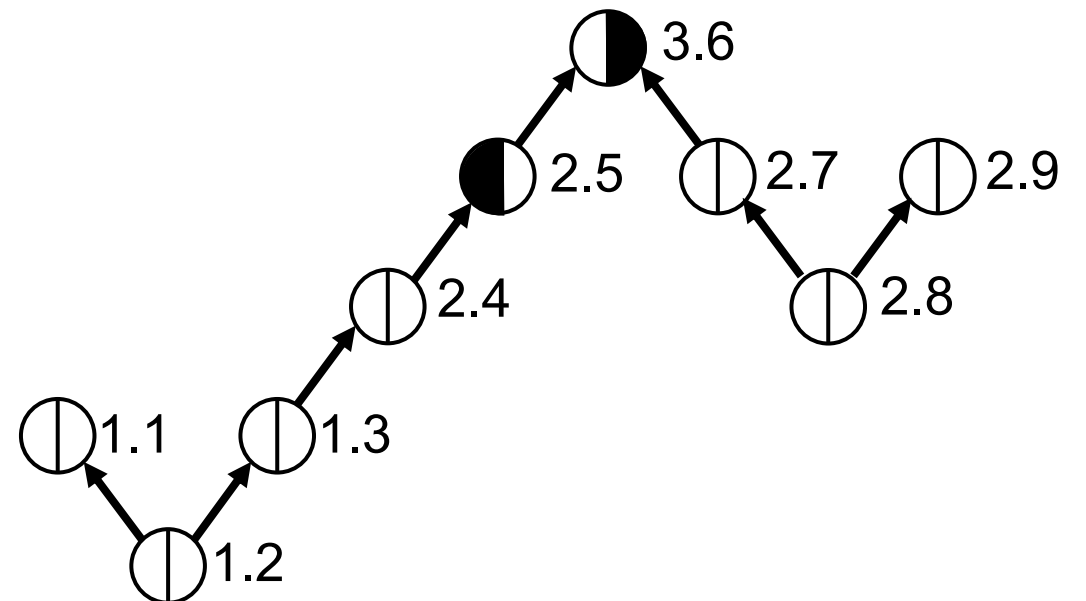

States depend on the cut

$A_5 A_6 A_4 G$

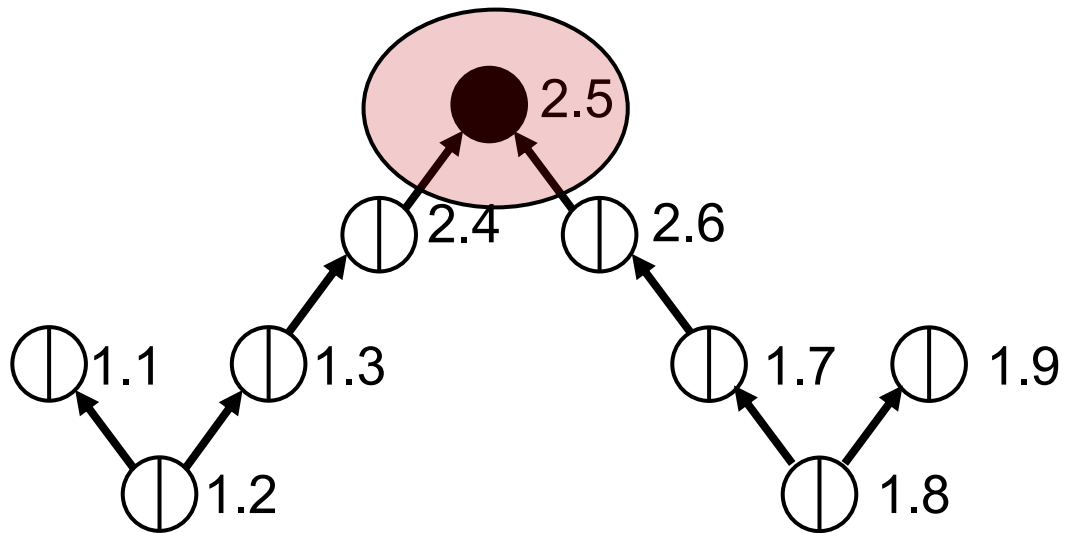

\neq

$A_6 A_9 A_7 A_8 A_5 A_6 A_4 G$

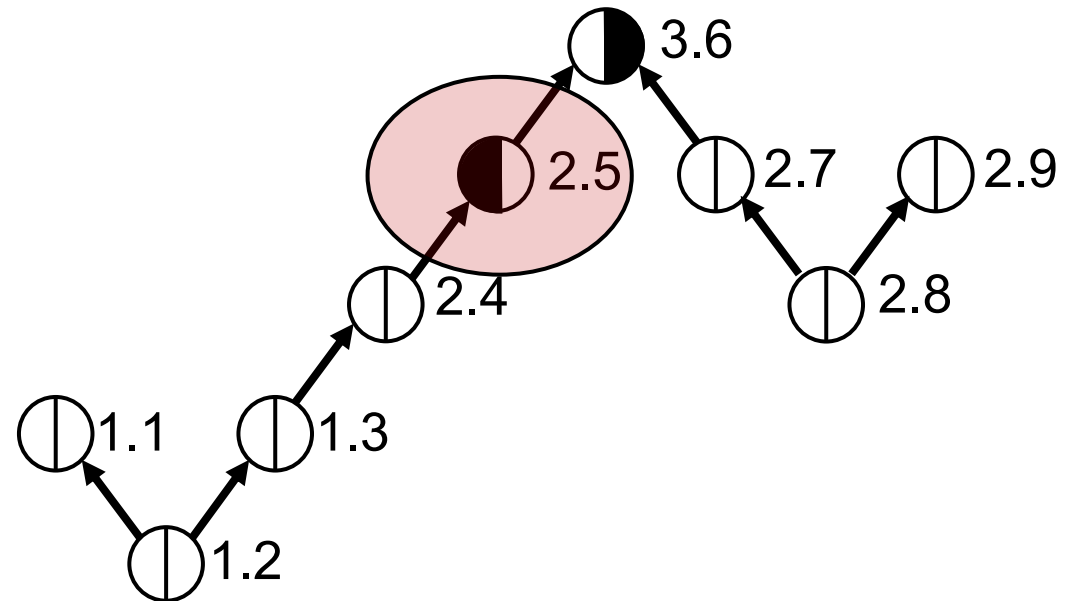

States depend on the cut

$$A_5 A_6 A_4 G = A_w$$

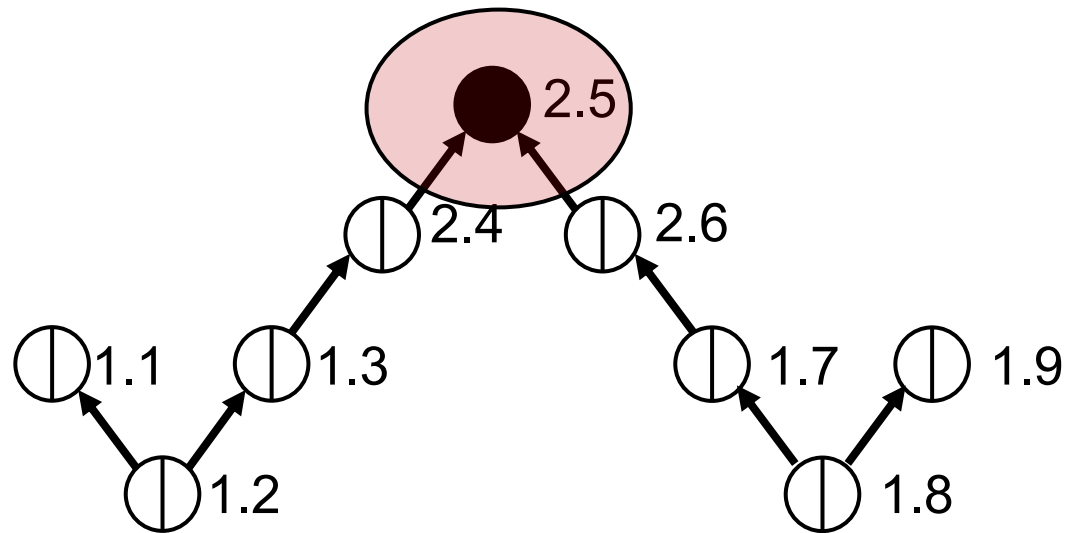

≠

$$A_6 A_9 A_7 A_8 A_5 A_4 G = A_w'$$

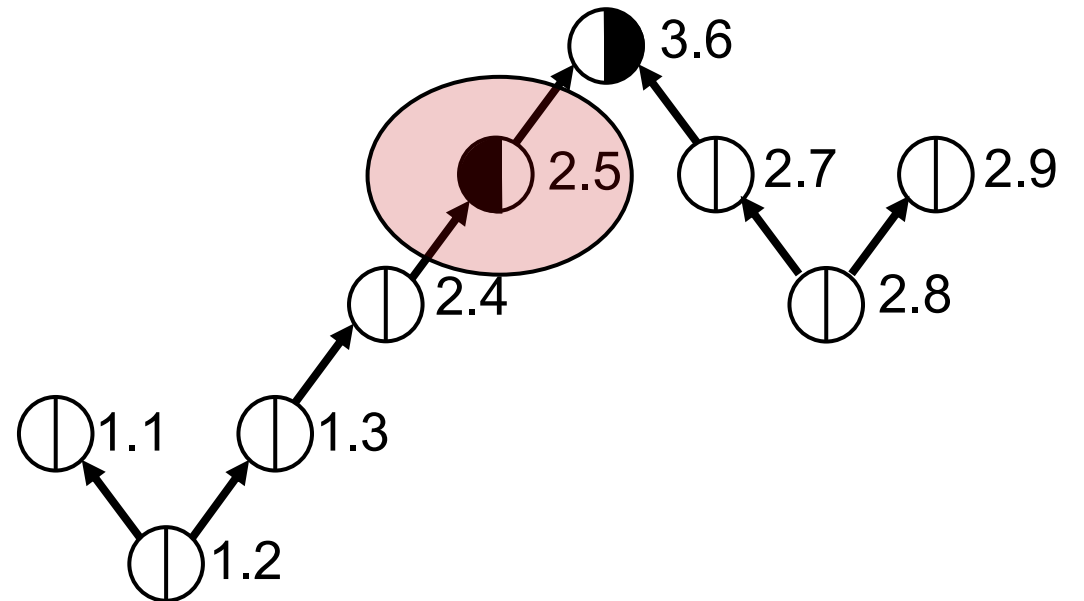

Space-time Determinism

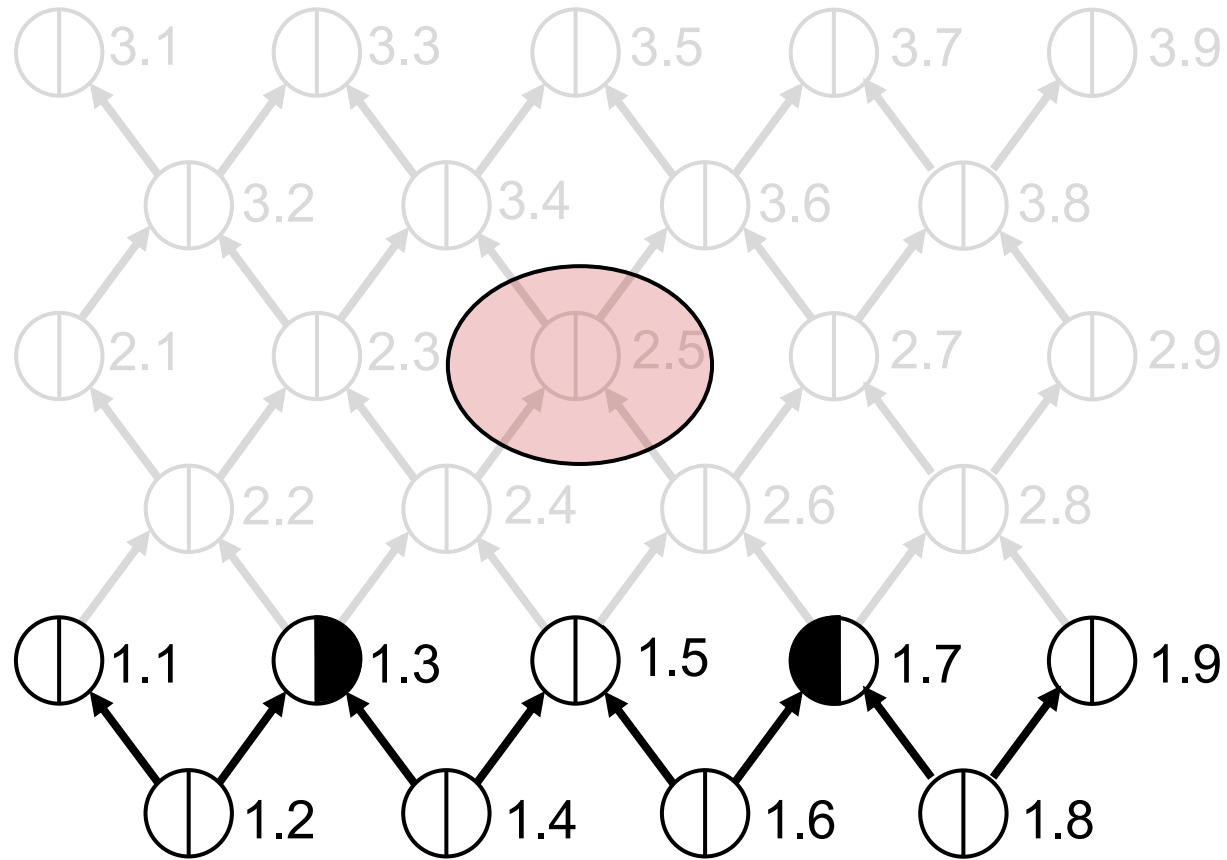

Space-time Determinism

The **state** of 2.5 is the **same for 2 locally identical cuts** passing by this node.

Space-time Determinism

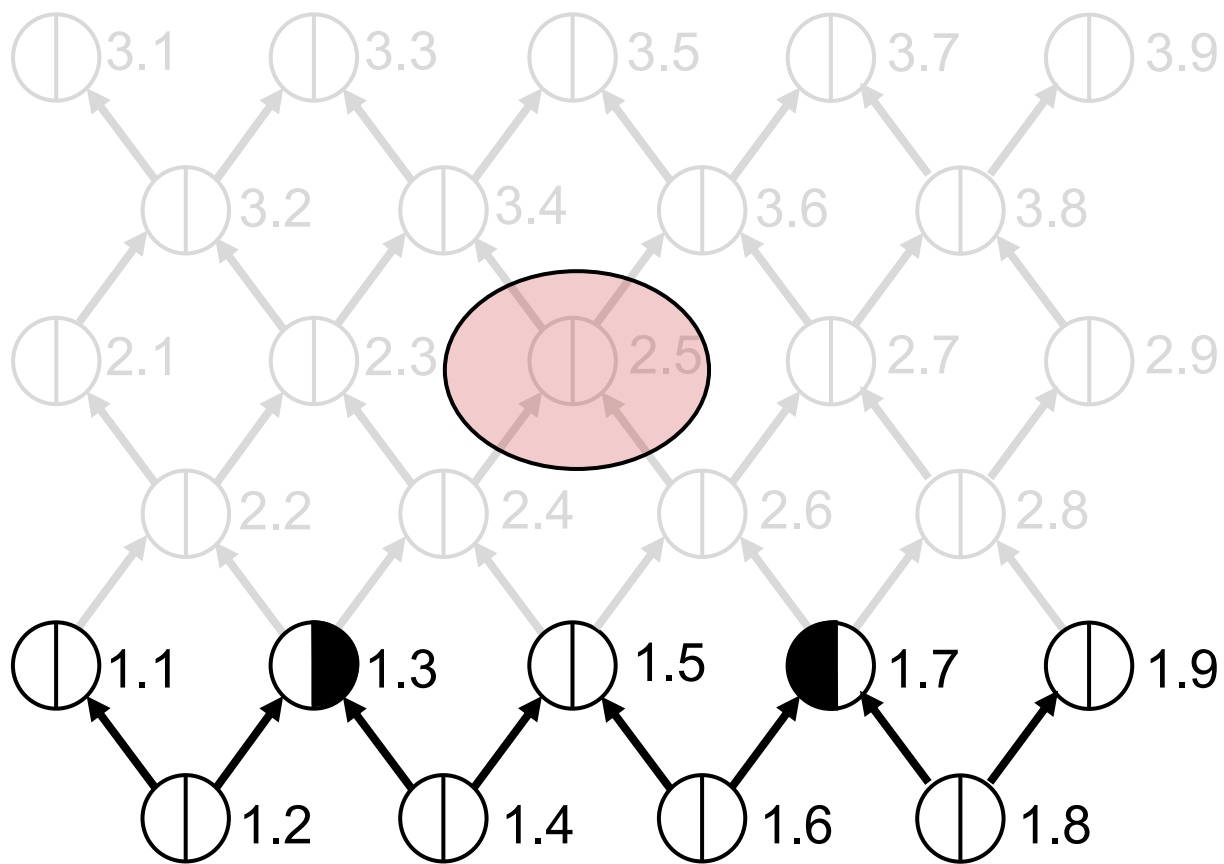

Space-time Determinism

The **state** of 2.5 is **the same for 2 locally identical cuts** passing by this node.

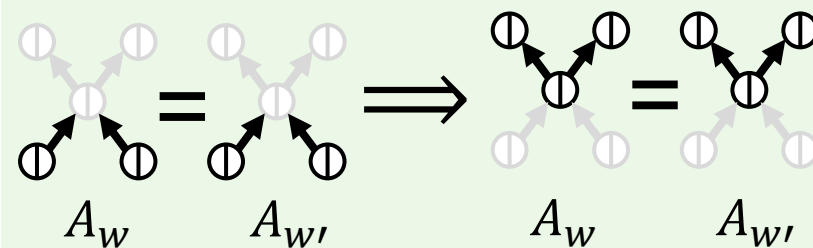

Space-time Determinism

$A_w G$

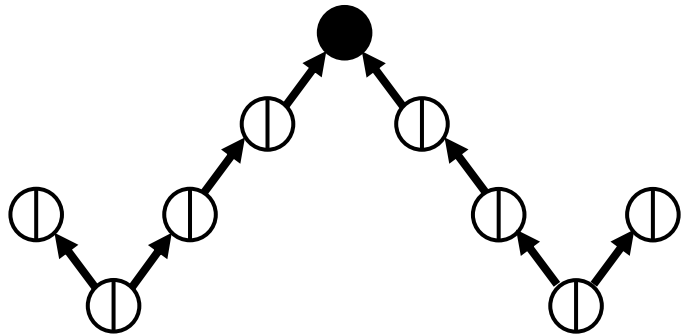

$A_{w'} G$

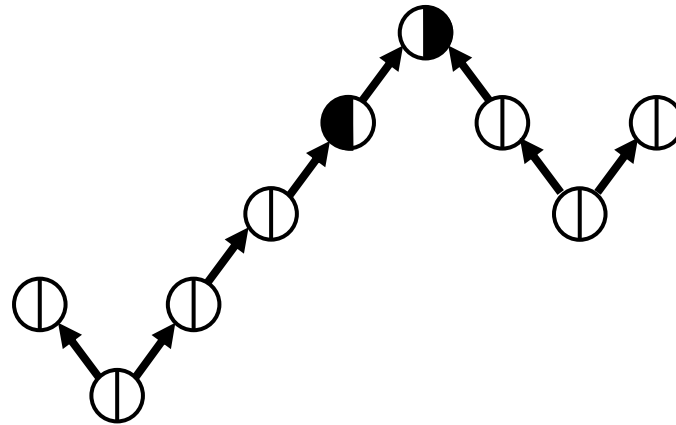

Space-time Determinism

The **state** of 2.5 is **the same for 2 locally identical cuts** passing by this node.

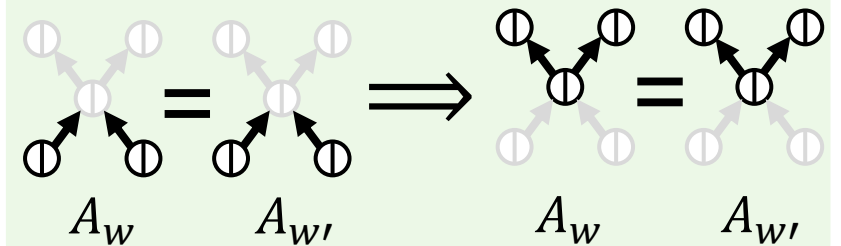

Space-time Determinism

$A_w G$

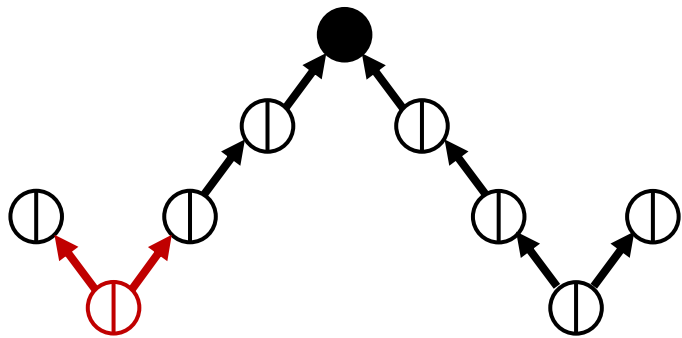

$A_{w'} G$

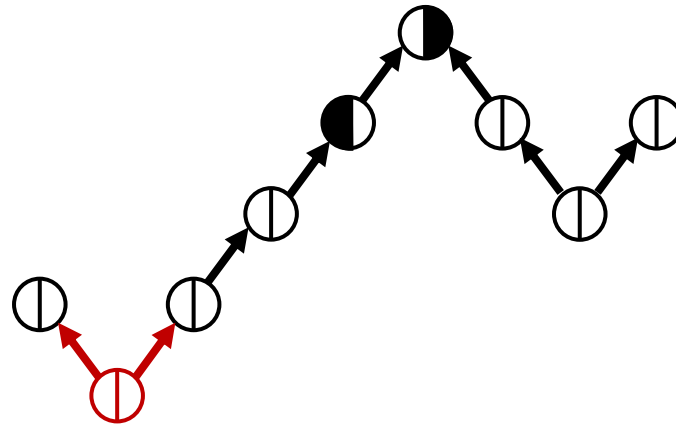

Space-time Determinism

The **state** of 2.5 is **the same for 2 locally identical cuts** passing by this node.

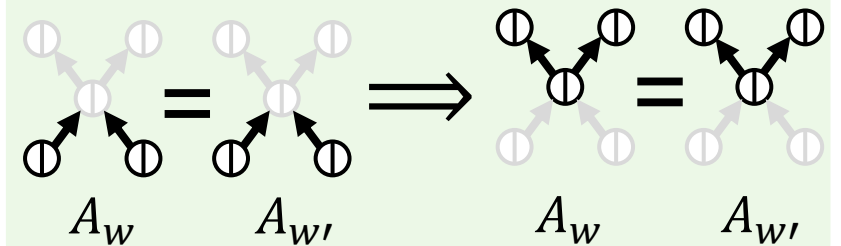

Space-time Determinism

$A_w G$

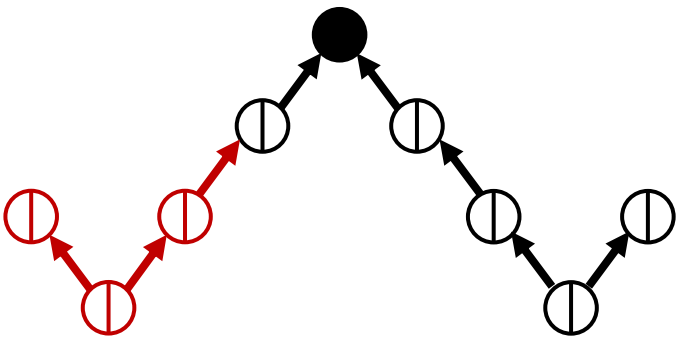

$A_{w'} G$

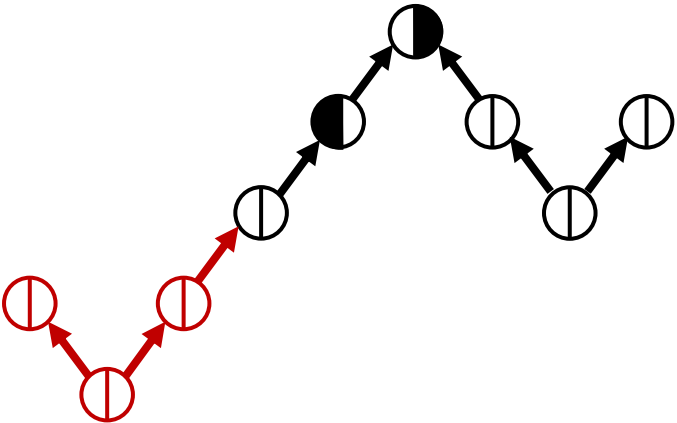

Space-time Determinism

The state of 2.5 is **the same for 2 locally identical cuts** passing by this node.

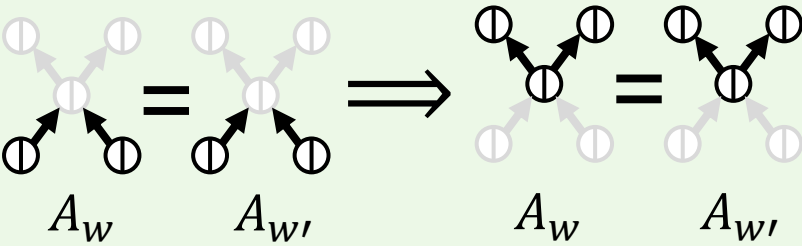

Space-time Determinism

$A_w G$

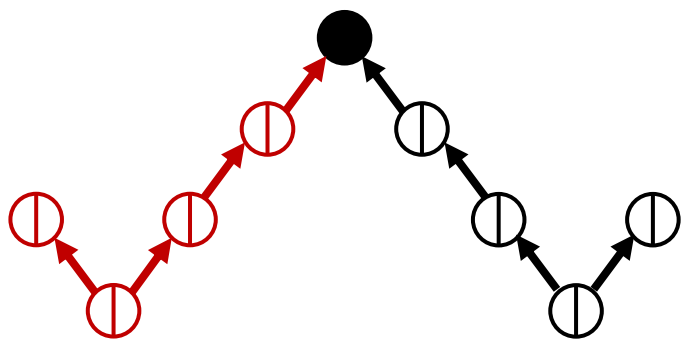

$A_{w'} G$

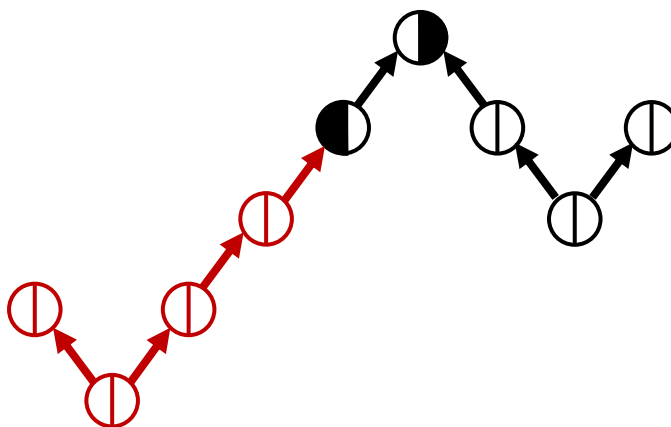

Space-time Determinism

The **state** of 2.5 is **the same for 2 locally identical cuts** passing by this node.

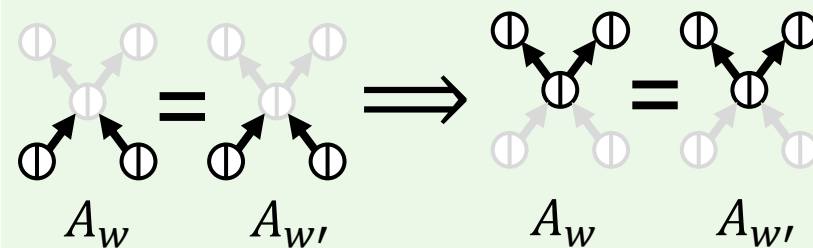

Space-time Determinism

$A_w G$

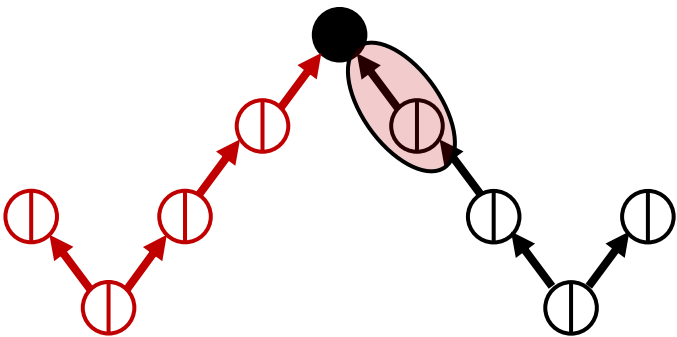

$A_{w'} G$

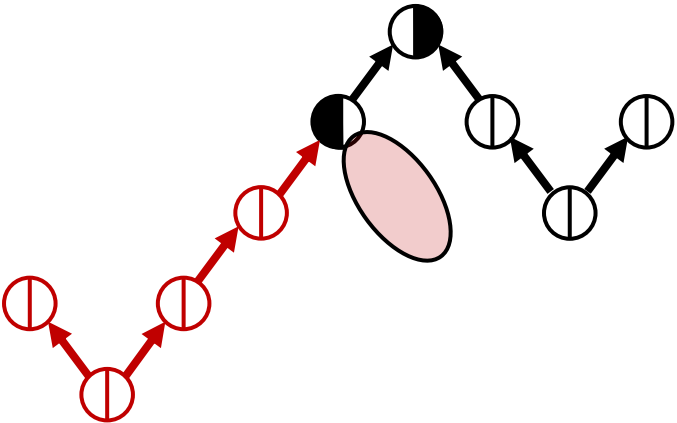

Space-time Determinism

The **state** of 2.5 is **the same for 2 locally identical cuts** passing by this node.

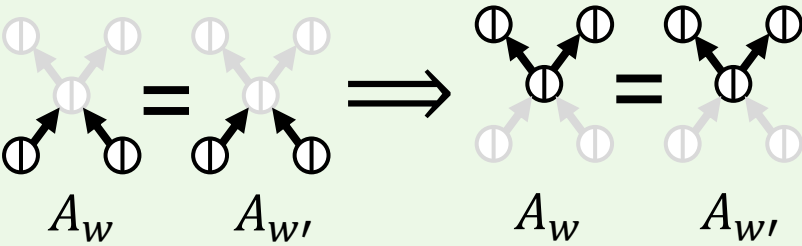

Space-time Determinism

$A_w G$

||

$A_{w'} G$

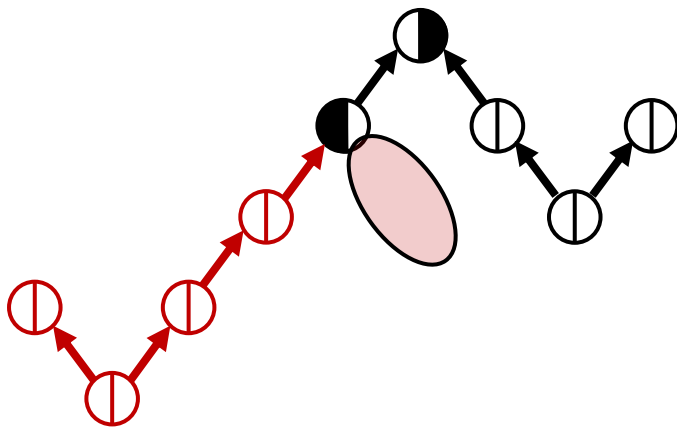
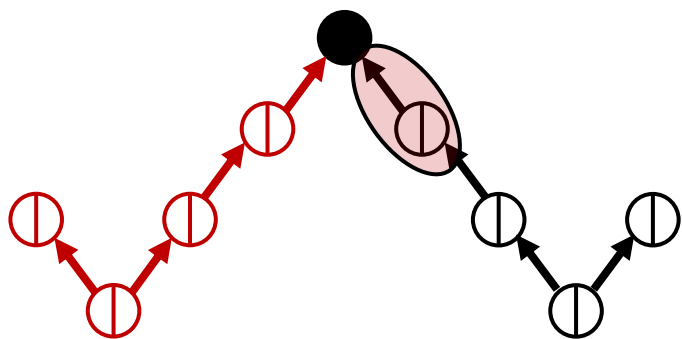

Space-time Determinism

The **state** of 2.5 is **the same for 2 locally identical cuts** passing by this node.

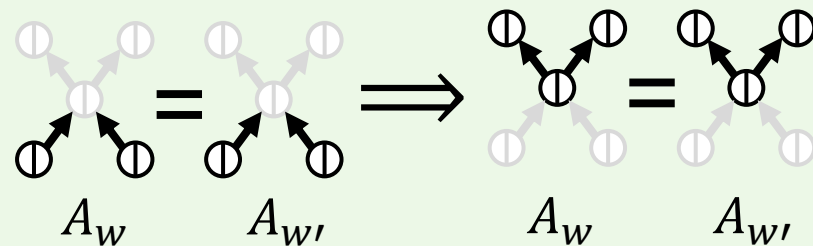

Ensuring determinism

Goal : prove A deterministic, i.e. we always have $A_w \parallel A_{w'}$:

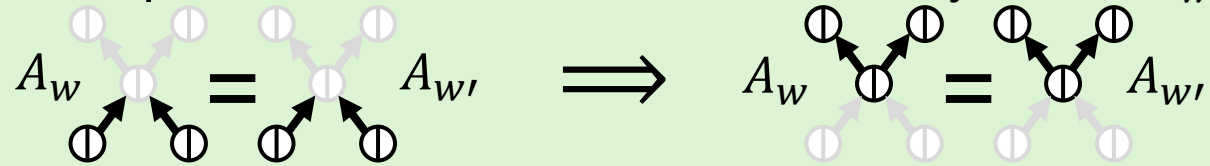

Hypothesis



Ensuring determinism

Goal : prove A deterministic, i.e. we always have $A_w \parallel A_{w'}$:

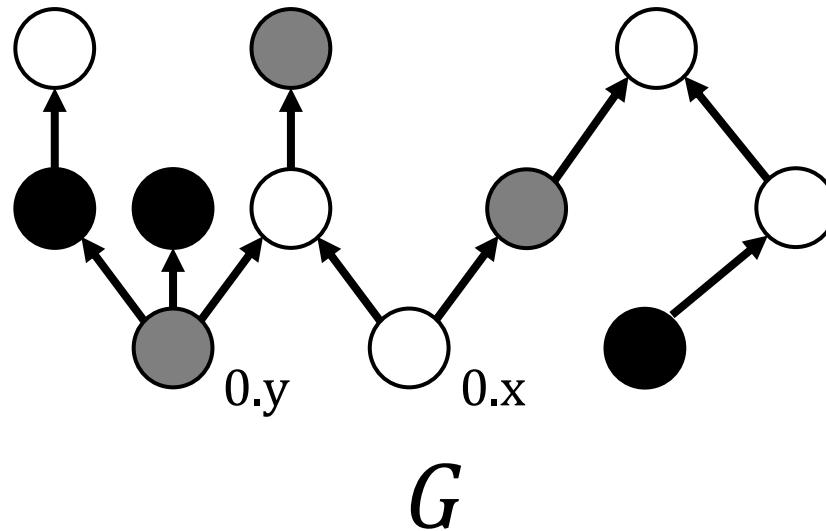
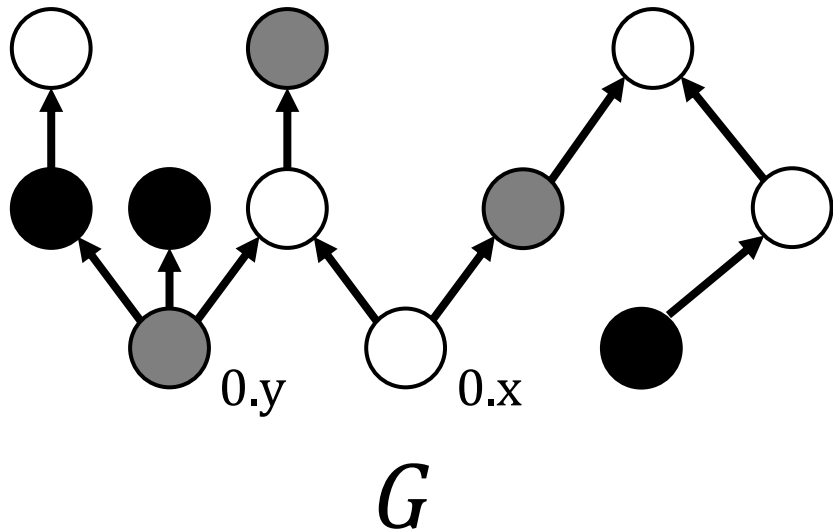
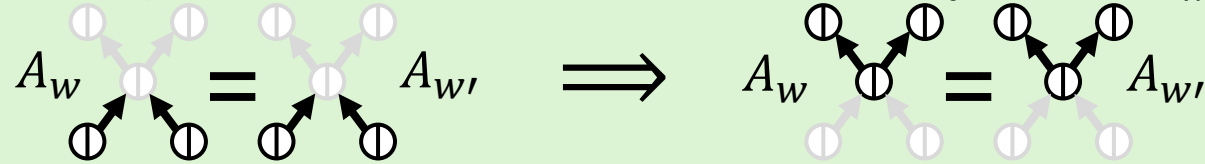

Hypothesis

1. Commutative
 $A_x A_y G = A_y A_x G$

Ensuring determinism

Goal : prove A deterministic, i.e. we always have $A_w \parallel A_{w'}$:

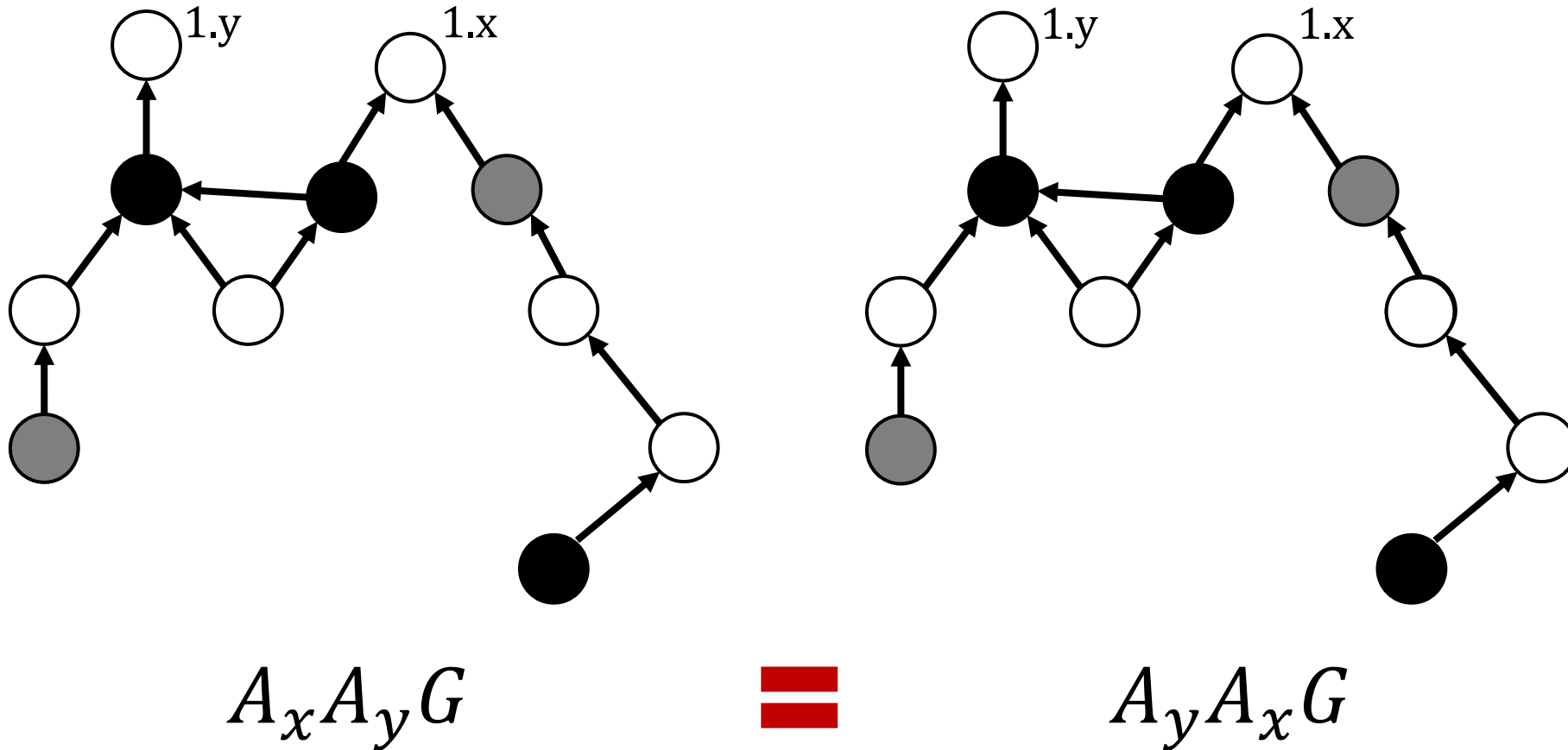
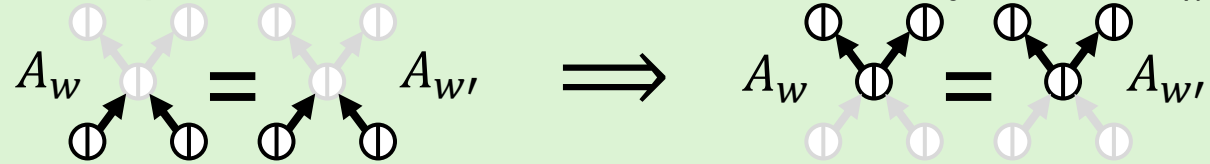

Hypothesis

1. Commutative
 $A_x A_y G = A_y A_x G$

Ensuring determinism

Goal : prove A deterministic, i.e. we always have $A_w || A_{w'}$:

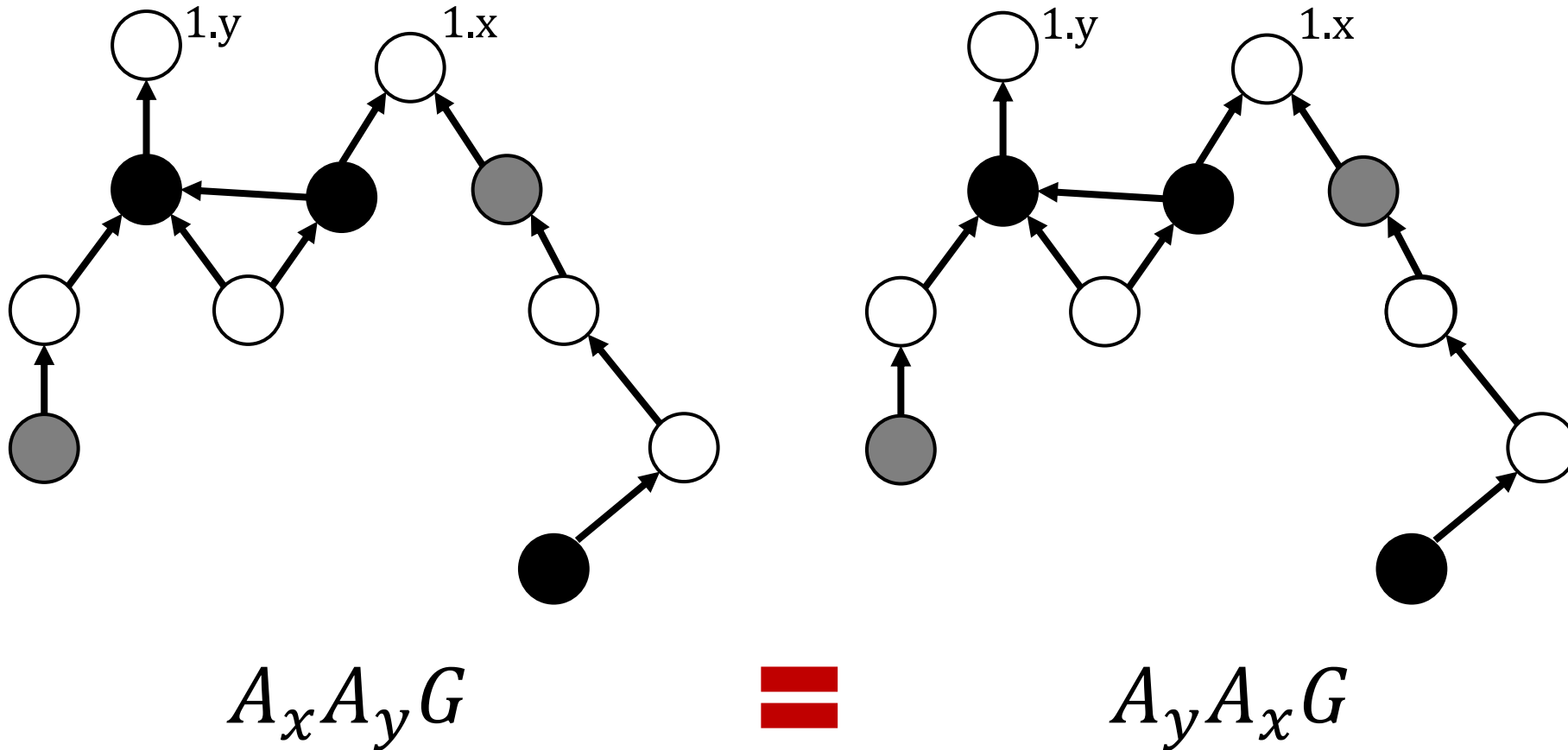
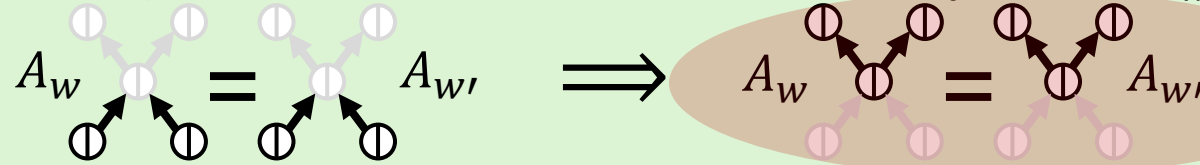

Hypothesis

- Commutative
 $A_x A_y G = A_y A_x G$

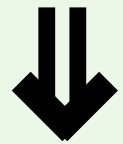

Consistent cuts

- $A_x A_y G || A_y A_x G$

Ensuring determinism

Goal : prove A deterministic, i.e. we always have $A_w || A_{w'}$:

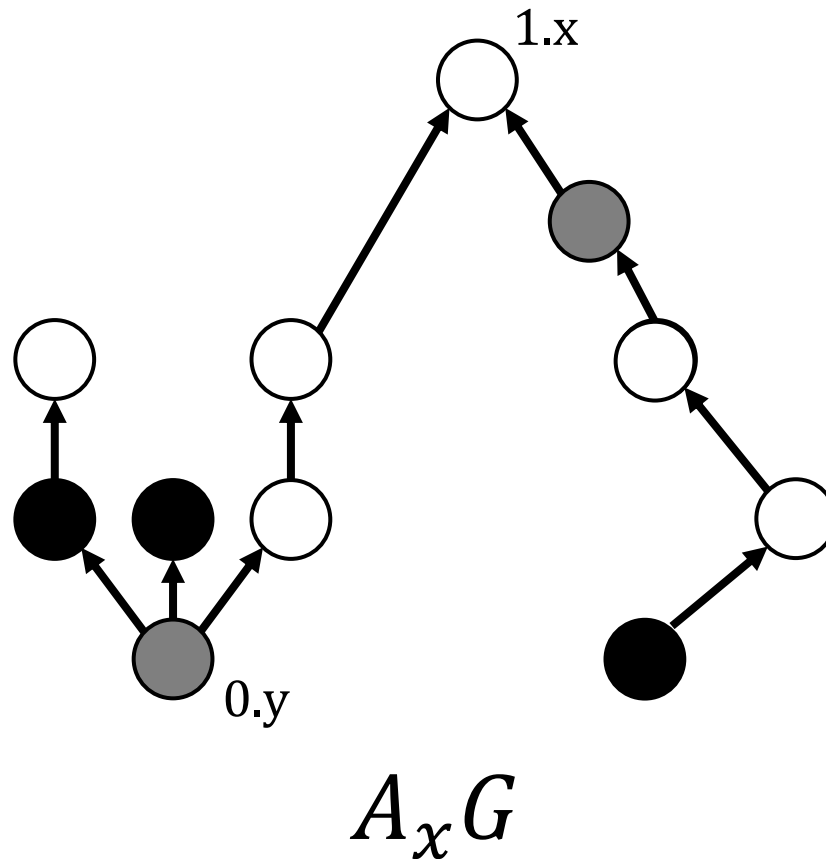
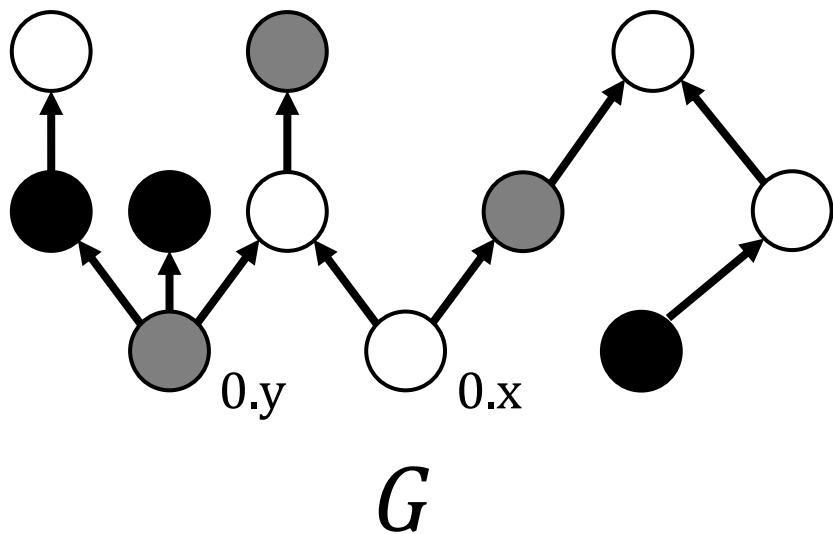
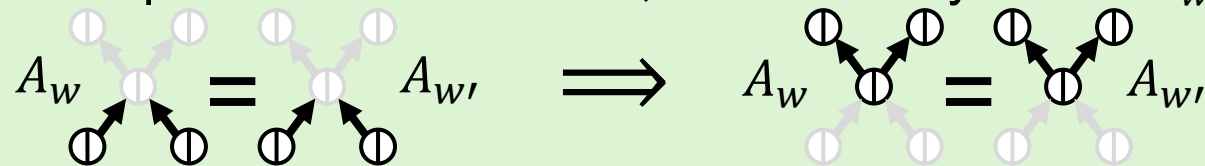

Hypothesis

- Commutative
 $A_x A_y G = A_y A_x G$

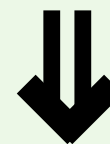

Consistent cuts

- $A_x A_y G || A_y A_x G$

Ensuring determinism

Goal : prove A deterministic, i.e. we always have $A_w || A_{w'}$:

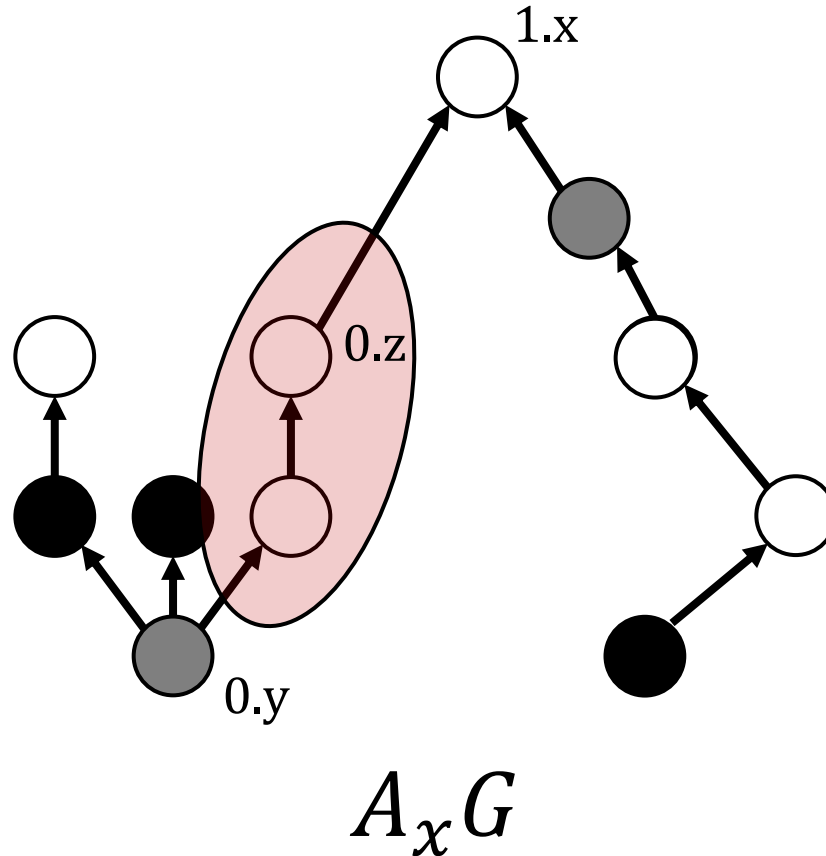
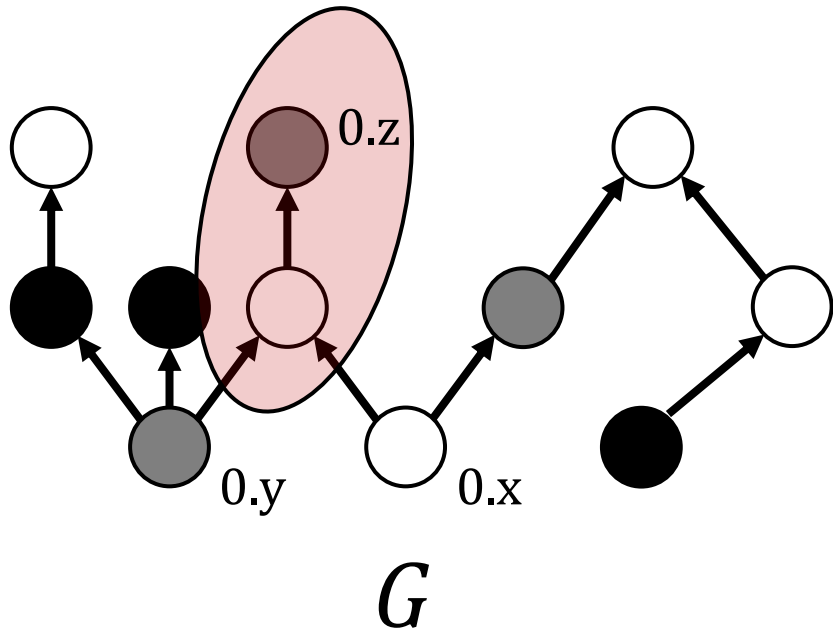
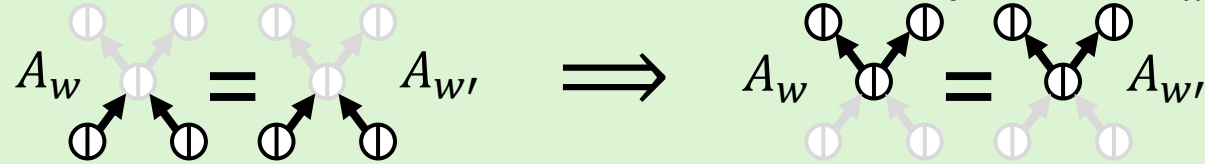

Hypothesis

- Commutative
 $A_x A_y G = A_y A_x G$

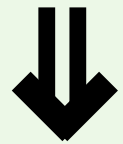

Consistent cuts

- $A_x A_y G || A_y A_x G$

Ensuring determinism

Goal : prove A deterministic, i.e. we always have $A_w || A_{w'}$:

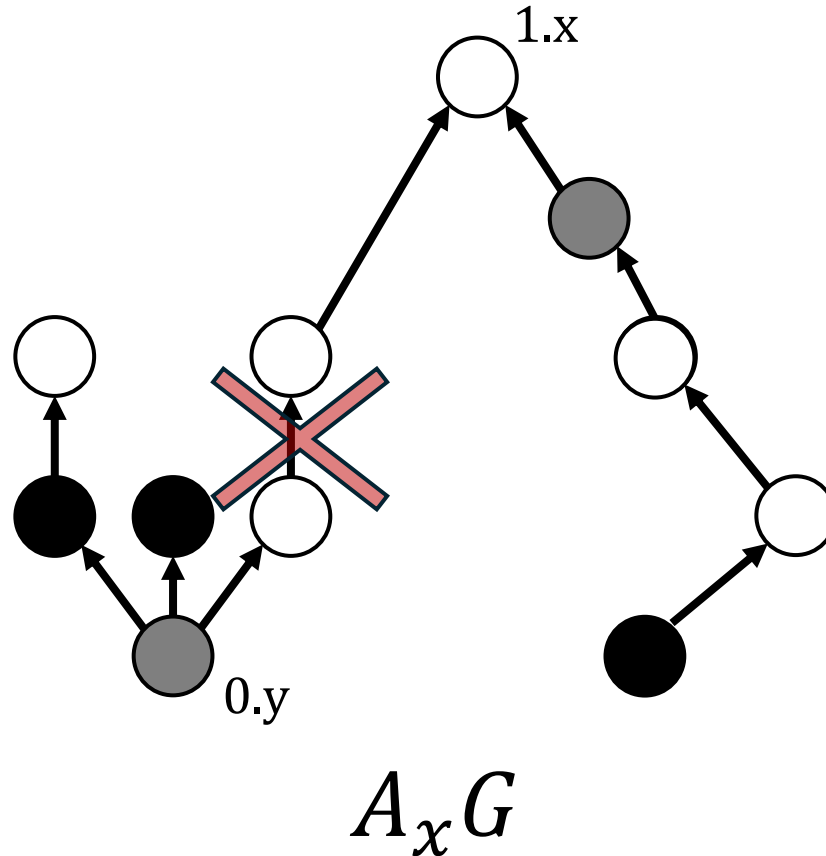
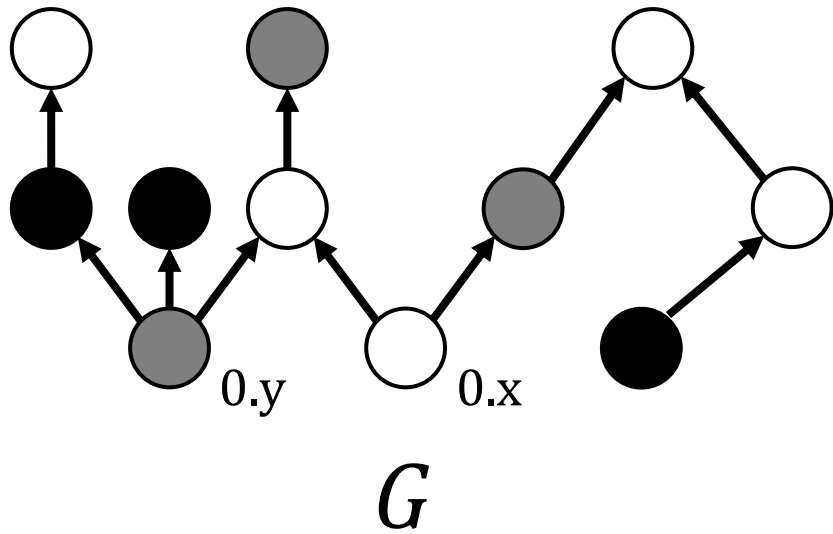
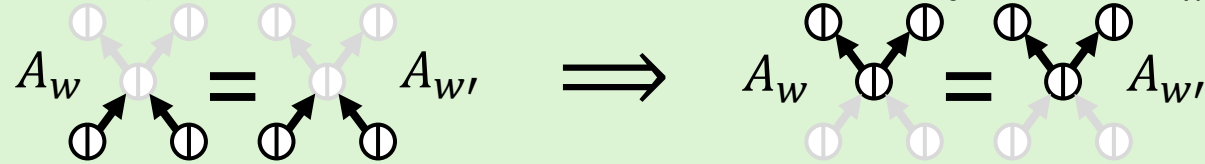

Hypothesis

1. Commutative
 $A_x A_y G = A_y A_x G$
2. Edge decreasing

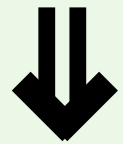

Consistent cuts

1. $A_x A_y G || A_y A_x G$

Ensuring determinism

Goal : prove A deterministic, i.e. we always have $A_w \parallel A_{w'}$:

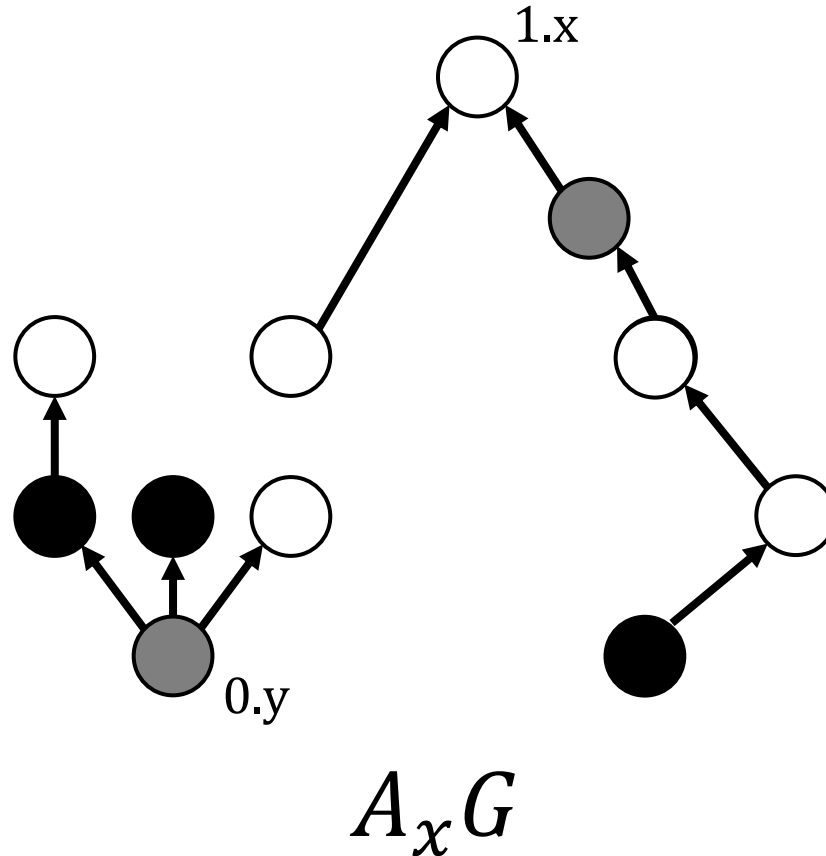
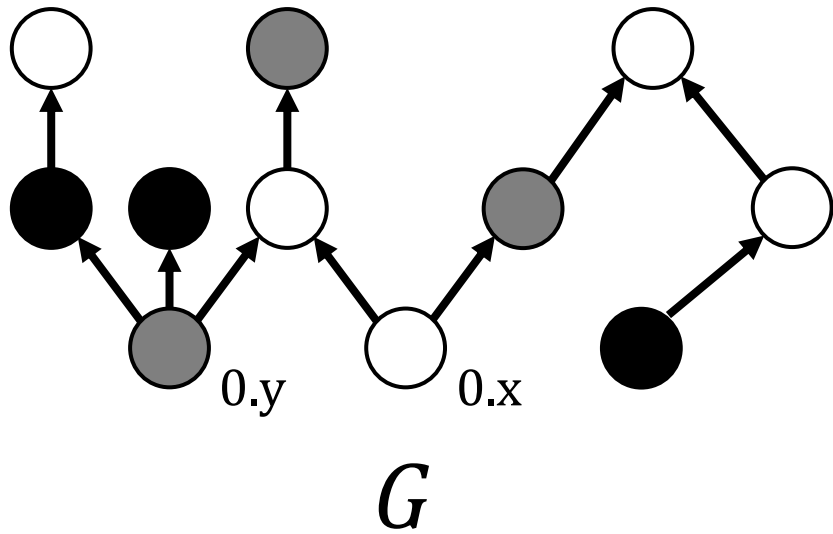
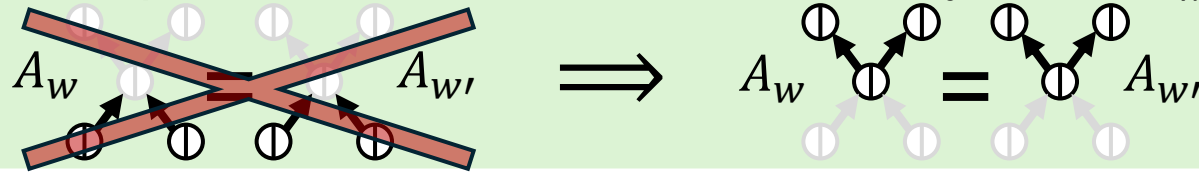

Hypothesis

1. Commutative
 $A_x A_y G = A_y A_x G$
2. Edge decreasing

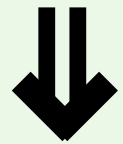

Consistent cuts

1. $A_x A_y G \parallel A_y A_x G$
2. $A_x G \parallel G$

Ensuring determinism

Goal : prove A deterministic, i.e. we always have $A_w || A_{w'}$:

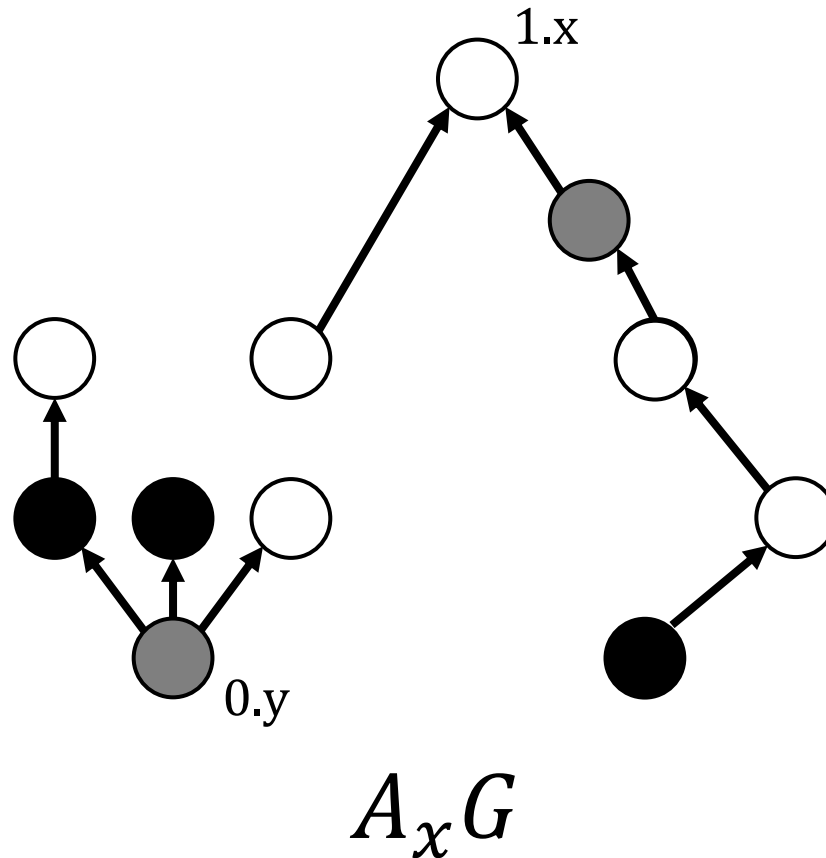
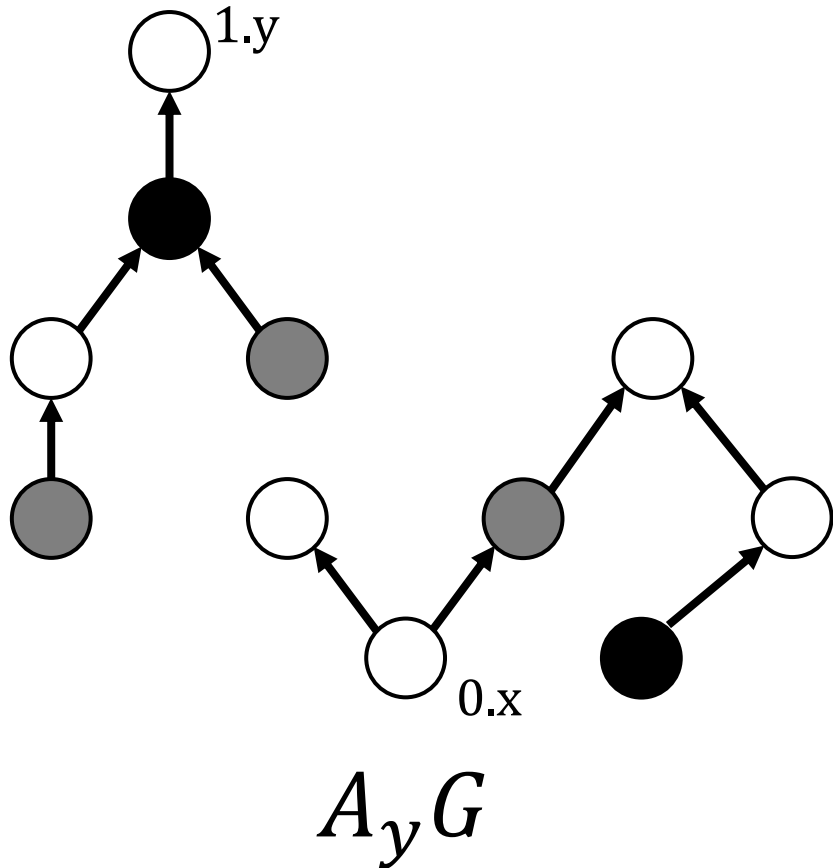
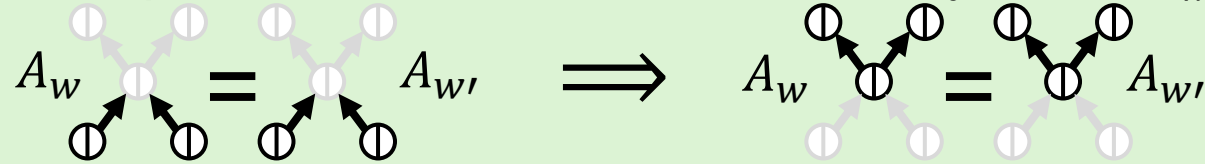

Hypothesis

1. Commutative
 $A_x A_y G = A_y A_x G$
2. Edge decreasing

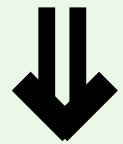

Consistent cuts

1. $A_x A_y G || A_y A_x G$
2. $A_x G || G$

Ensuring determinism

Goal : prove A deterministic, i.e. we always have $A_w || A_{w'}$:

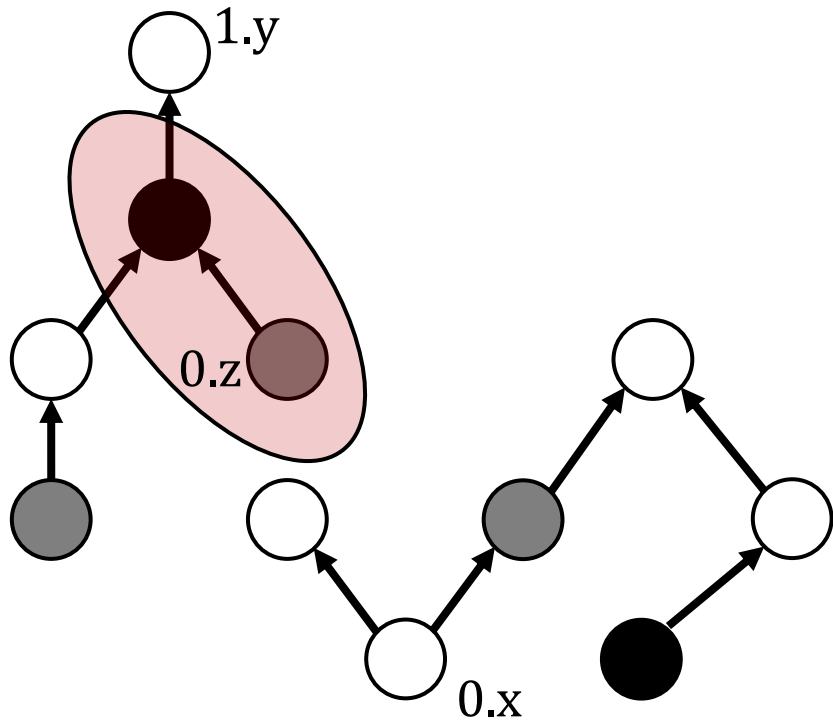
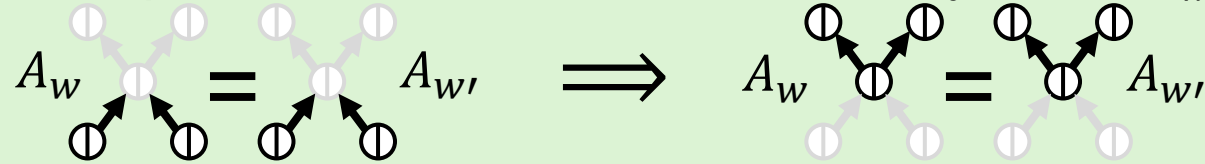

$A_y G$

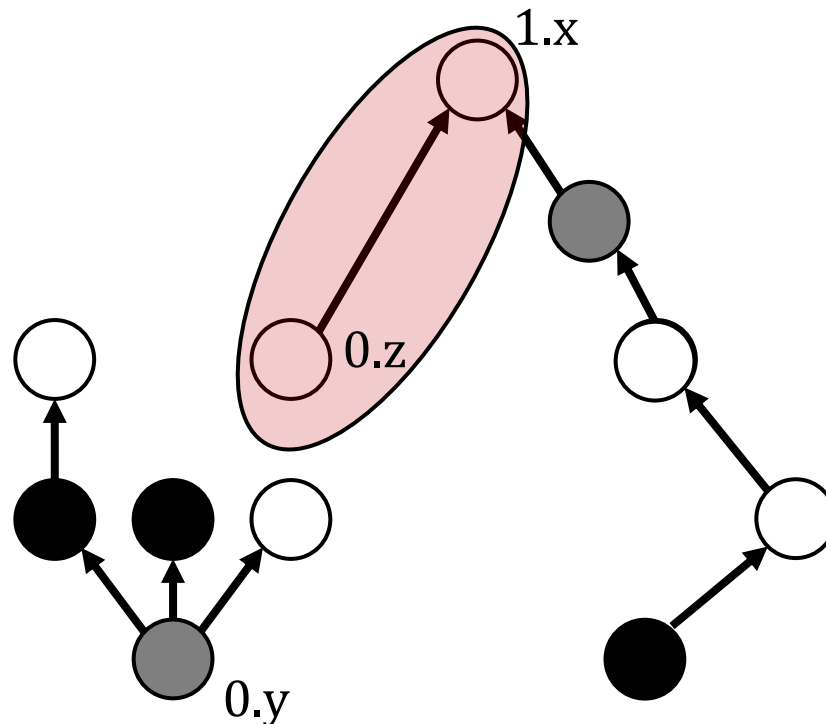

$A_x G$

Hypothesis

1. Commutative
 $A_x A_y G = A_y A_x G$
2. Edge decreasing

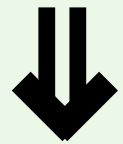

Consistent cuts

1. $A_x A_y G || A_y A_x G$
2. $A_x G || G$

Ensuring determinism

Goal : prove A deterministic, i.e. we always have $A_w || A_{w'}$:

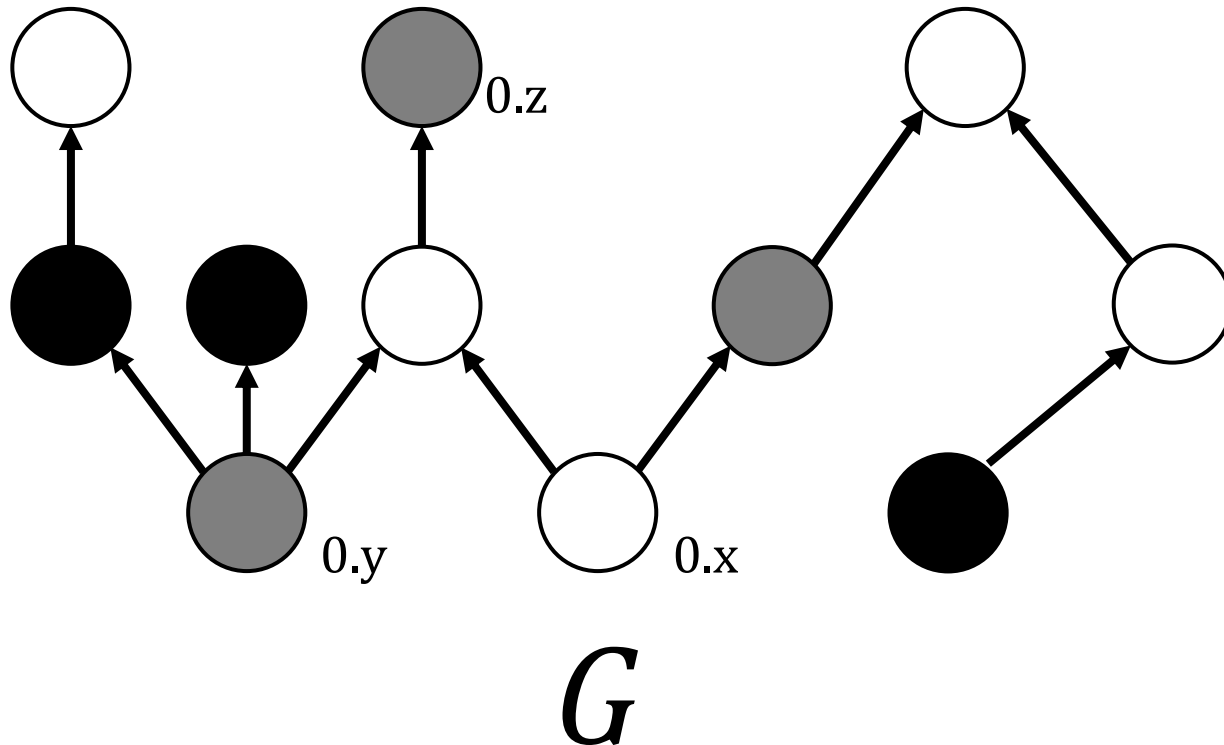
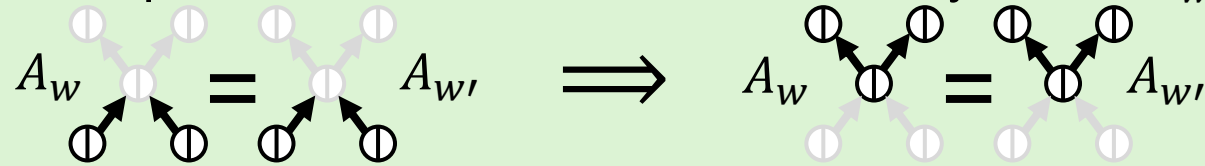

Hypothesis

1. Commutative
 $A_x A_y G = A_y A_x G$
2. Edge decreasing

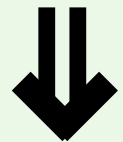

Consistent cuts

1. $A_x A_y G || A_y A_x G$
2. $A_x G || G$

Ensuring determinism

Goal : prove A deterministic, i.e. we always have $A_w || A_{w'}$:

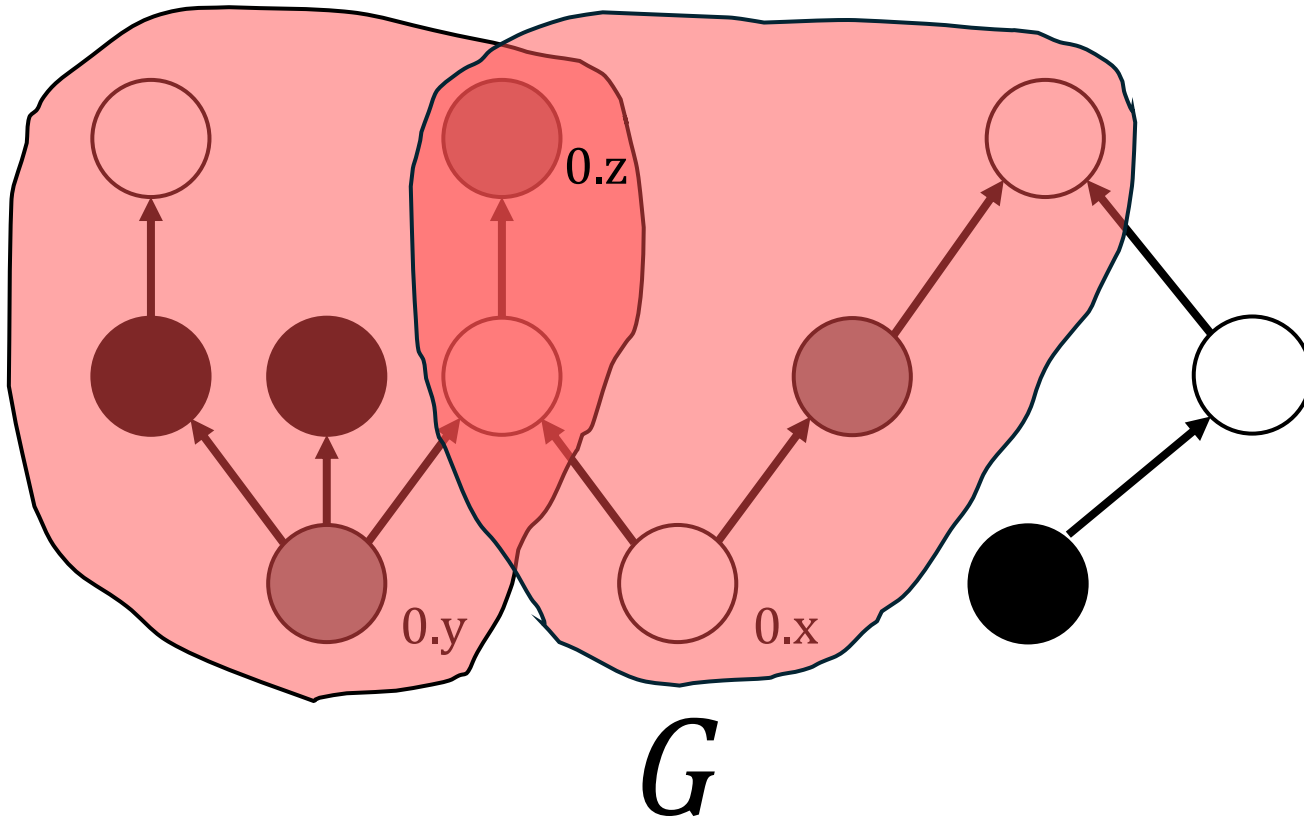
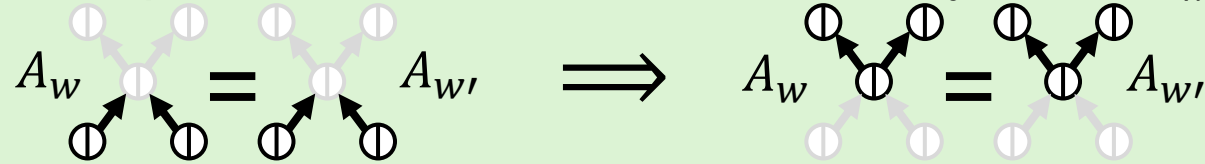

Hypothesis

1. Commutative
 $A_x A_y G = A_y A_x G$
2. Edge decreasing

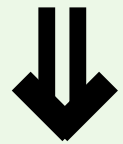

Consistent cuts

1. $A_x A_y G || A_y A_x G$
2. $A_x G || G$

Ensuring determinism

Goal : prove A deterministic, i.e. we always have $A_w || A_{w'}$:

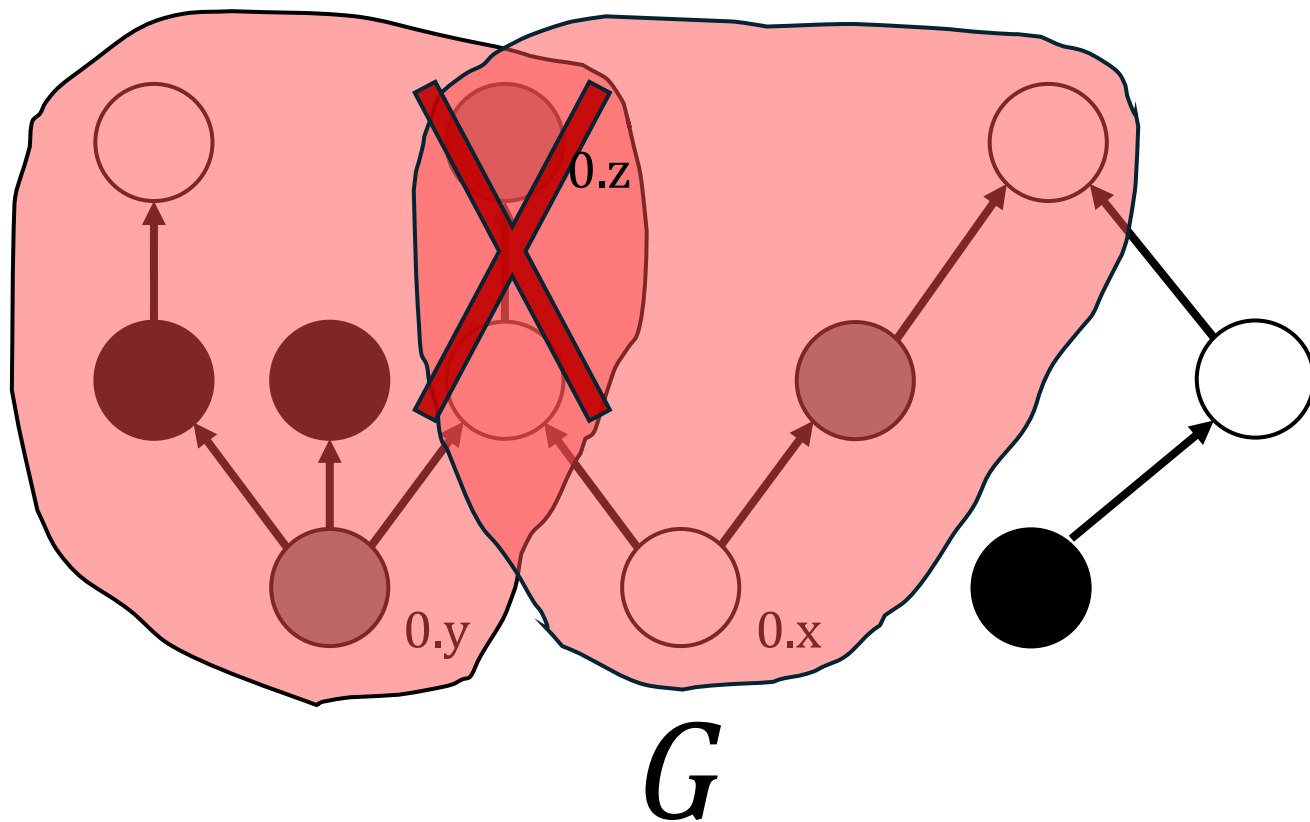
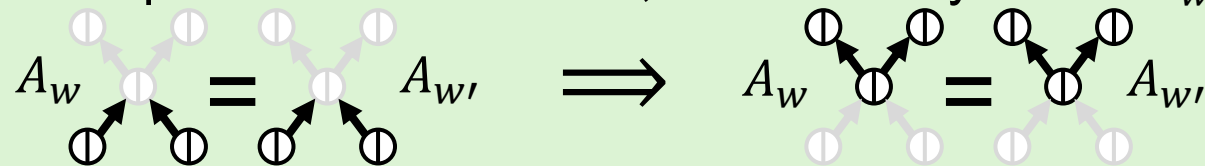

Hypothesis

1. Commutative
 $A_x A_y G = A_y A_x G$
2. Edge decreasing
3. Private

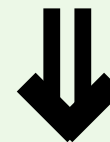

Consistent cuts

1. $A_x A_y G || A_y A_x G$
2. $A_x G || G$

Ensuring determinism

Goal : prove A deterministic, i.e. we always have $A_w || A_{w'}$:

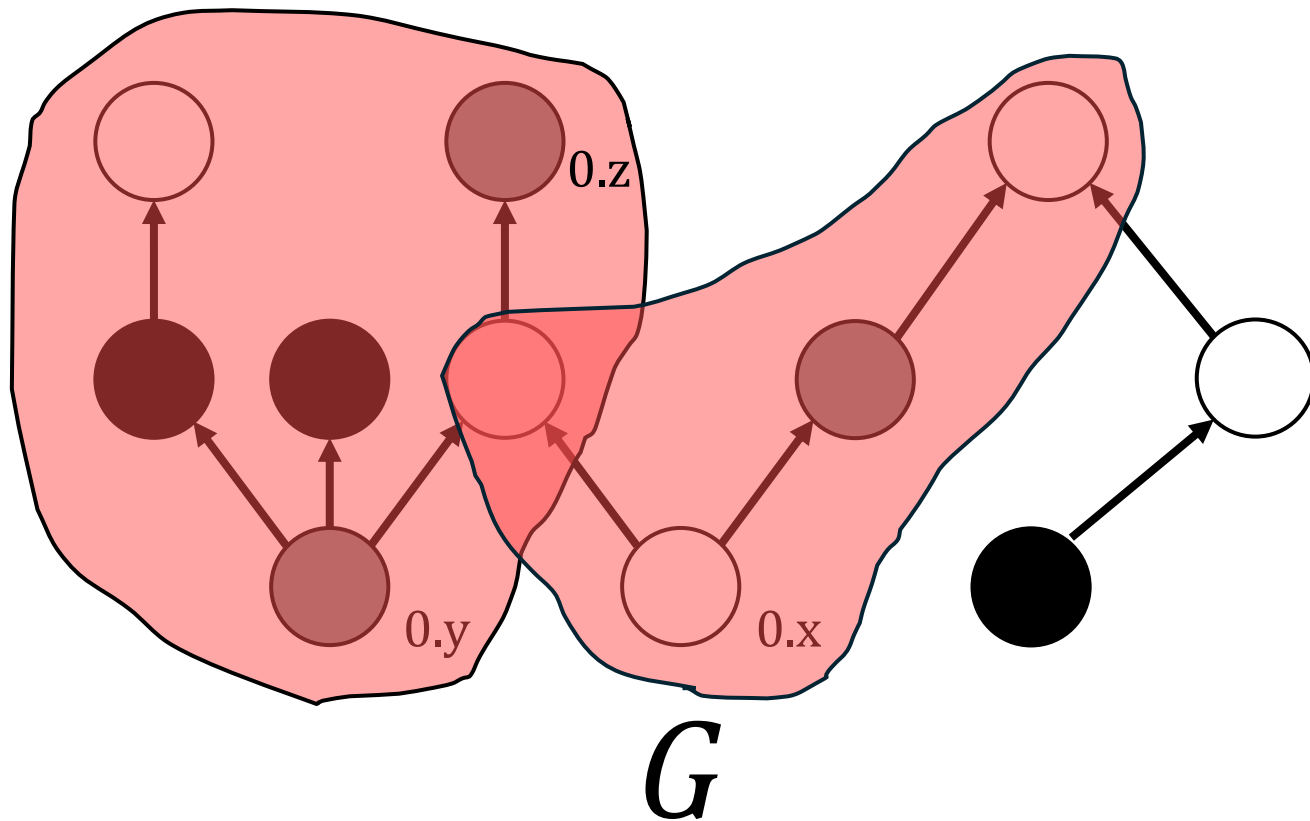
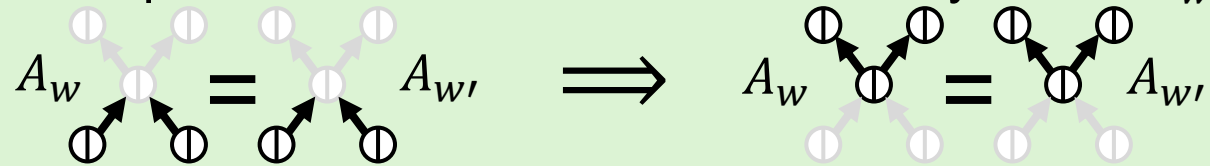

Hypothesis

1. Commutative
 $A_x A_y G = A_y A_x G$
2. Edge decreasing
3. Private

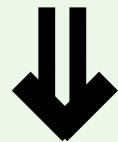

Consistent cuts

1. $A_x A_y G || A_y A_x G$
2. $A_x G || G$
3. $A_x G || A_y G$

Ensuring determinism

Goal : prove A deterministic, i.e. we always have $A_w \parallel A_{w'}$:

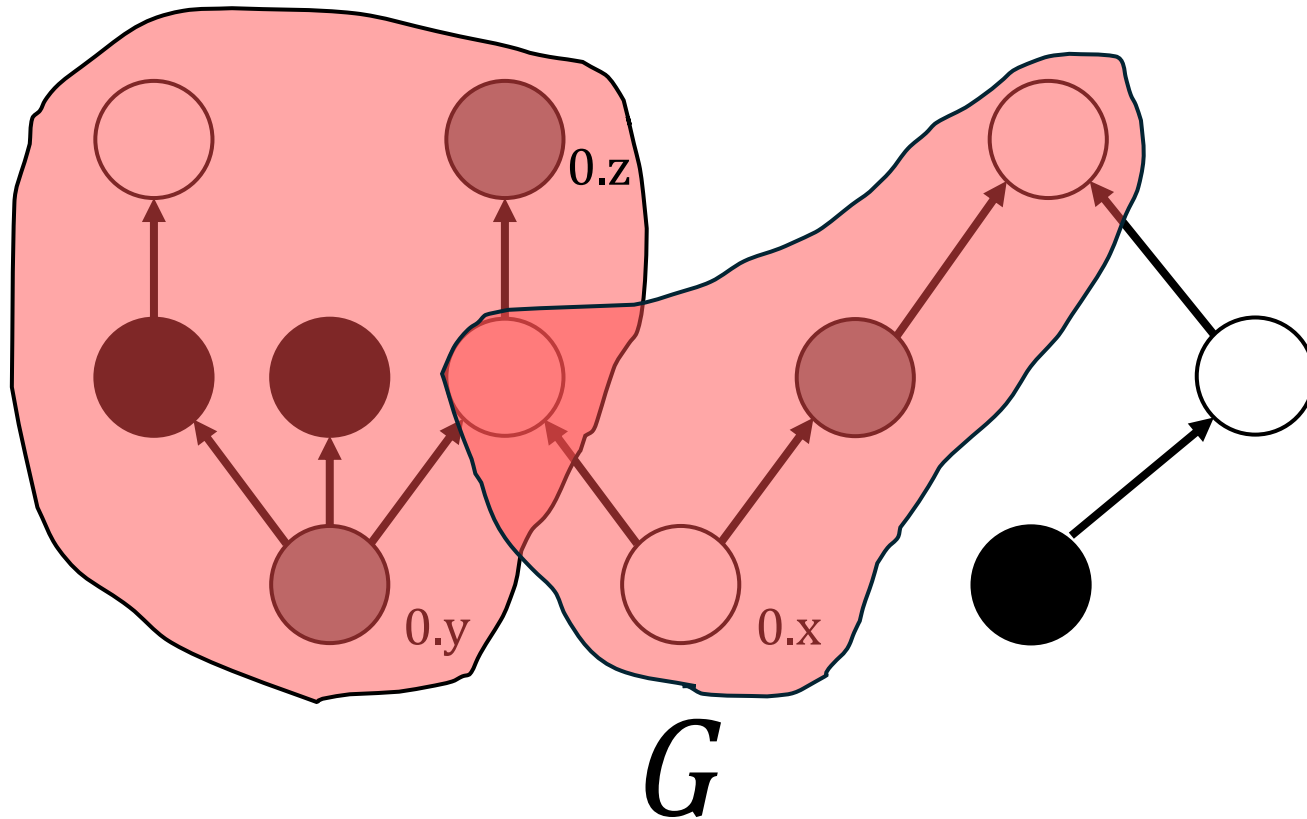
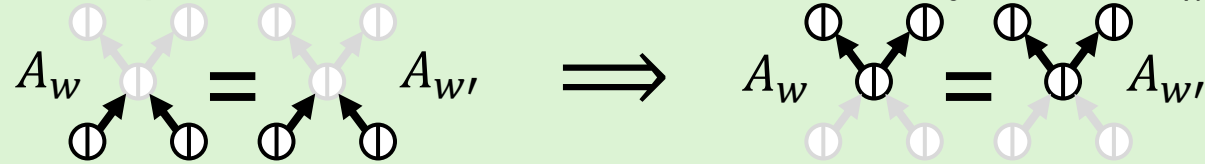

Hypothesis

1. Commutative
 $A_x A_y G = A_y A_x G$
2. Edge decreasing
3. Private

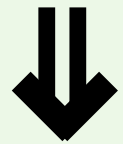

Consistent cuts

1. $A_x A_y G \parallel A_y A_x G$
2. $A_x G \parallel G$
3. $A_x G \parallel A_y G$
4. $A_w G \parallel A_{w'} G$

Ensuring determinism

Goal : prove A deterministic, i.e. we always have $A_w \parallel A_{w'}$:

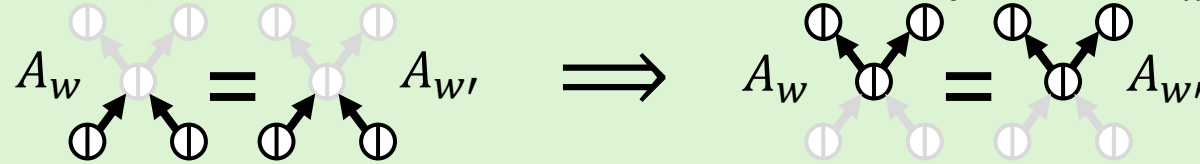

Theorem 1

Any commutative, edge decreasing and private local rule is deterministic.

Hypothesis

1. Commutative
 $A_x A_y G = A_y A_x G$
2. Edge decreasing
3. Private

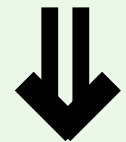

Consistent cuts

1. $A_x A_y G \parallel A_y A_x G$
2. $A_x G \parallel G$
3. $A_x G \parallel A_y G$
4. $A_w G \parallel A_{w'} G$

Conclusion

Particle system

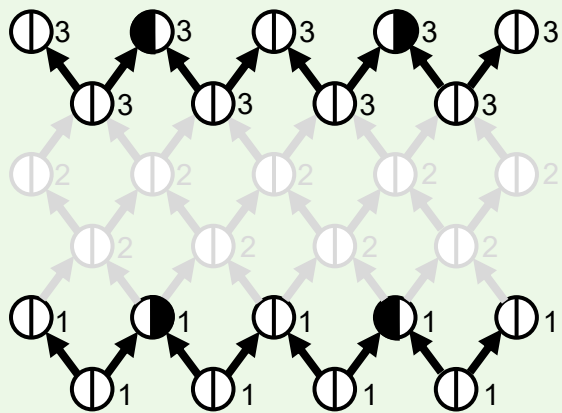

Time dilation

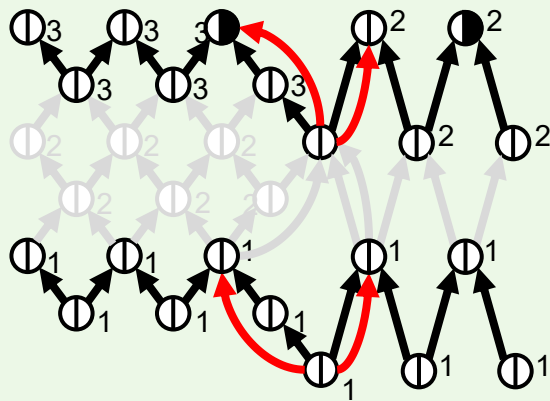

Space-time Determinism

1. Commutative
2. Edge decreasing
3. Private

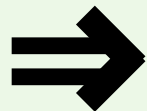

$$A_W G \quad || \quad A_{W'} G$$

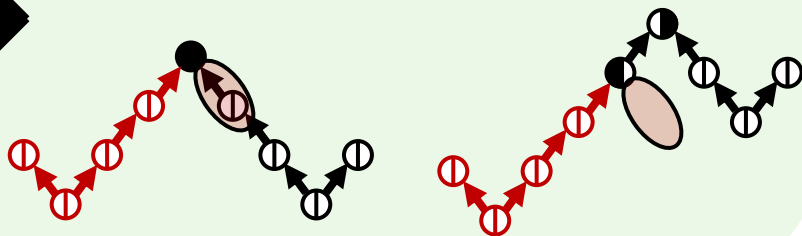

Conclusion

Particle system

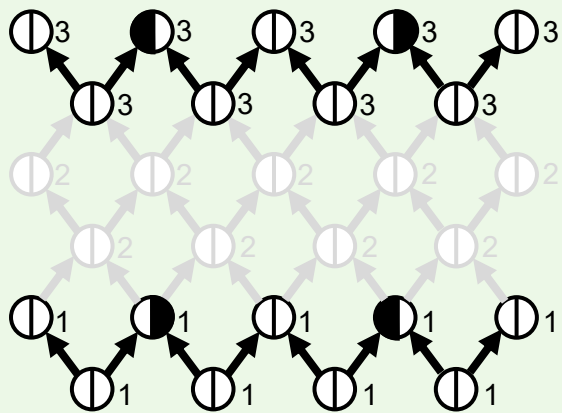

Time dilation

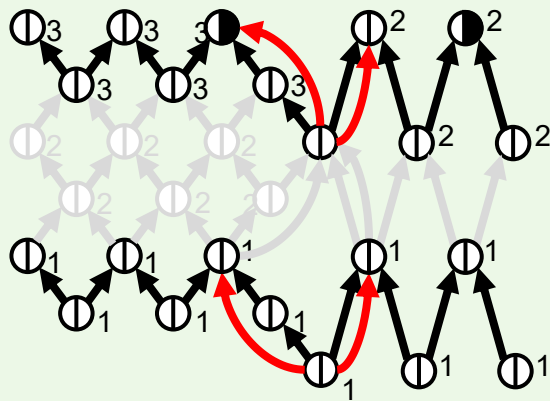

Space-time Determinism

1. Commutative
2. Edge decreasing
3. Private

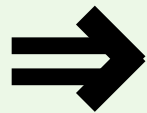

$$A_W G \quad || \quad A_{W'} G$$

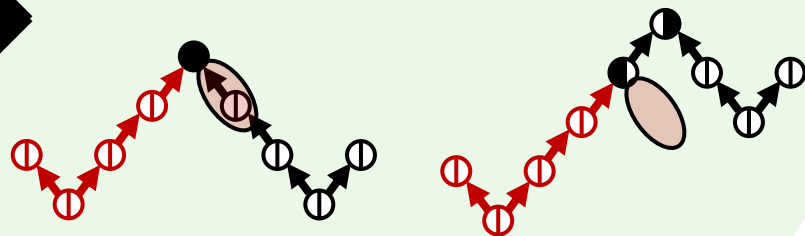

Quantum ?

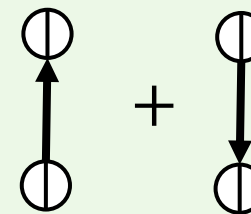

Black hole simulation ?

